

SCS Climbing System

The solid bracket system for single-sided and two-sided climbing formwork operations

Product Brochure

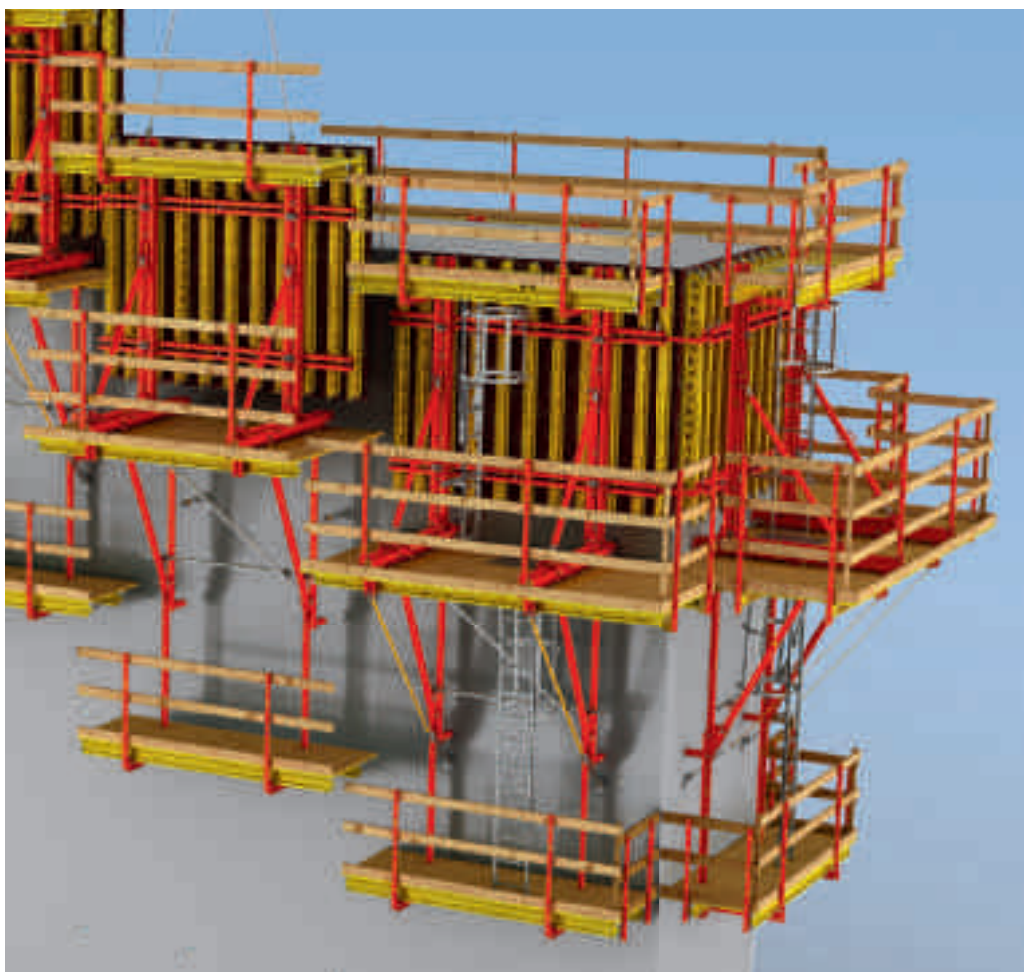

Content

SCS Climbing System		System overview	
2	Developed for a construction project of the century	16	The SCS Climbing System at a glance
		18	Regular operating sequence with SCS
		20	Execution details
SCS system advantages			
4	The solid bracket system for single and two-sided applications		
6	Description of the SCS versions		
8	Large, craneable climbing units		
10	Material-optimized solution		
12	Safe, horizontal working areas		
14	Also suitable for two-sided applications		

Edition 12 | 2016

Publisher

PERI GmbH
Formwork Scaffolding Engineering
Rudolf-Diesel-Strasse 19
89264 Weissenhorn
Germany
Tel. +49 (0)7309.950-0
Fax +49 (0)7309.951-0
info@peri.com
www.peri.com

Project examples
22 The SCS Climbing System
in use

Components
30 SCS Climbing System

Contacting PERI
60 PERI International

Important information

All current safety regulations and guidelines must be observed in those countries where our products are used.

The photos shown in this brochure feature construction sites in progress. For this reason, safety and anchor details in particular cannot always be considered as conclusive or final. These are subject to the risk assessment carried out by the contractor.

In addition, computer graphics are used which are to be understood as system representations. For ensuring a better understanding, these and the detailed illustrations shown have been partially

reduced to certain aspects. The safety installations which have possibly not been shown in these detailed descriptions must nevertheless be available. The systems or items shown might not be available in every country.

Safety instructions and load specifications are to be strictly observed at all times. Separate structural calculations are required for any deviations from the standard design data.

The information contained herein is subject to technical changes in the interests of progress. Errors and typographical mistakes reserved.





SCS Climbing System

For the construction of dams, locks, cooling towers, pier heads, tunnels and other similar structural components, formwork elements can very often only be positioned on one side while, at the same time, it would not be suitable to install any anchoring for the formwork due to the large spacing to the elements positioned on the opposite side. For these so-called single-sided applications, PERI has developed the SCS Climbing System. The very high load-bearing and flexible bracket solution was used for the first time in the Panama Canal expansion project. From 2011 to 2014, the SCS proved itself on countless occasions. Through a further development, the system components can also be used for two-sided applications.



SCS Climbing System

The solid bracket system for single-sided and two-sided climbing formwork operations

The SCS Climbing System is predominantly used for single-sided applications, i.e. with non-tied wall formwork. The loads resulting from the fresh concrete pressure are thereby transferred via the brackets into the previous concreting section by climbing anchors. Typical areas of applications for the SCS Climbing System are dams, locks, cooling towers, bunkers and strongroom vaults, pier heads and tunnels. With very few additional components, the brackets are also suitable for forming with anchored wall formwork.

With the SCS system, two bracket units together with one PERI wall formwork section form a crane-movable platform unit. Optionally, VARIO GT 24 Girder Wall Formwork as well as TRIO or MAXIMO Panel Formwork can be used.

The SCS Climbing System has been optimized for a concreting height of 3.00 m (vertical applications) or 2.50 m (forward-inclined applications). If required, a finishing platform can be added. With only a minimum of additional components, the use with anchored formwork is also possible for walls up to 6.00 m high.

The SCS Climbing System is characterized by a high level of cost-effectiveness: on the one hand, the well thought-out modular concept with multi-part brackets facilitates easy and simple adaptation to suit project-specific requirements and geometries. On the other, the high load-bearing capacity of the brackets allows wide climbing units which, in turn, reduces material requirements and workload respectively. Thanks to the modular design, SCS can be delivered already pre-assembled with subsequent fast final assembly on the jobsite.

With SCS, full consideration is also given to safety: if inclined components are formed, the inclination of the working platforms can be adjusted separately; in addition, the concreting and finishing platforms can be tilted by $\pm 15^\circ$ and $\pm 30^\circ$ respectively. Ladders with hatches ensure safe access to working levels; end-to-end side protection can be attached to all platforms.

Large, craneable climbing units

due to the particularly high load-bearing capacity of the brackets with good utilization of the anchoring

Material-optimized solution

with the same formwork and components for the starter and subsequent standard cycles

Safe, horizontal working areas

through inclinable platforms which can easily be adapted to suit inclined structural elements

Cost-effective also for two-sided applications

through a minimum of additional components for a high level of material utilization and reduced logistical requirements

SCS Climbing System

Description of the SCS versions

SCS 190

Bracket width approx. 1.90 m with tilting device for striking operations

The Bracket SCS 190 has a width of 1.90 m and requires only a minimum of space as well as being a more cost-effective alternative. The formwork is simply tilted when striking.

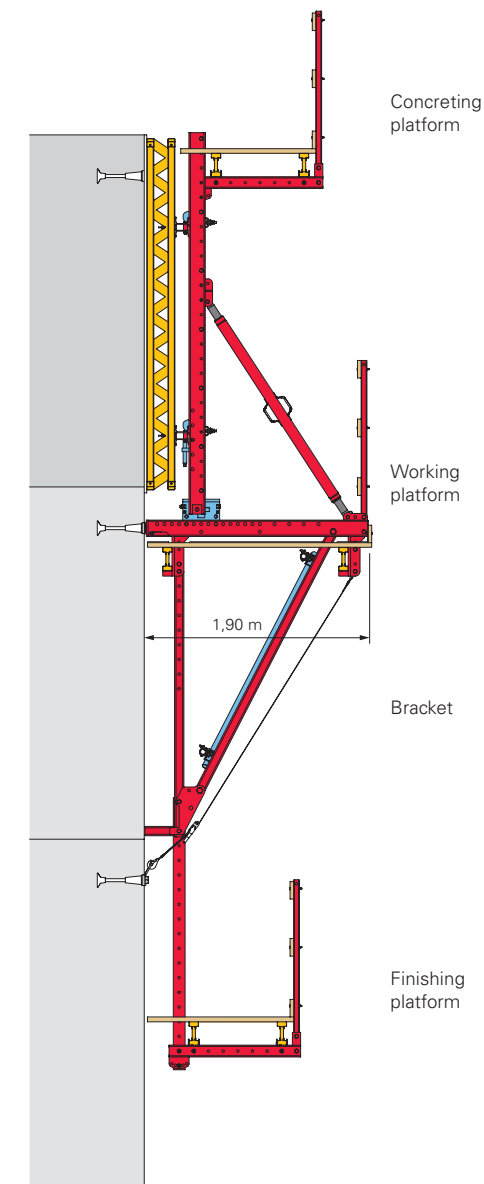

SCS 250

Bracket width approx. 2.50 m With carriage and up to 67 cm retraction distance

The SCS 250 has a width of 2.50 m and is equipped with a formwork carriage. With this, the wall formwork can be retracted up to 79 cm (valid for MAXIMO and TRIO) or up to 63 cm (valid for VARIO GT 24) without requiring a crane. This provides sufficient space for the reinforcement work, assembly of the scaffold anchoring as well as shuttering and striking of box outs.

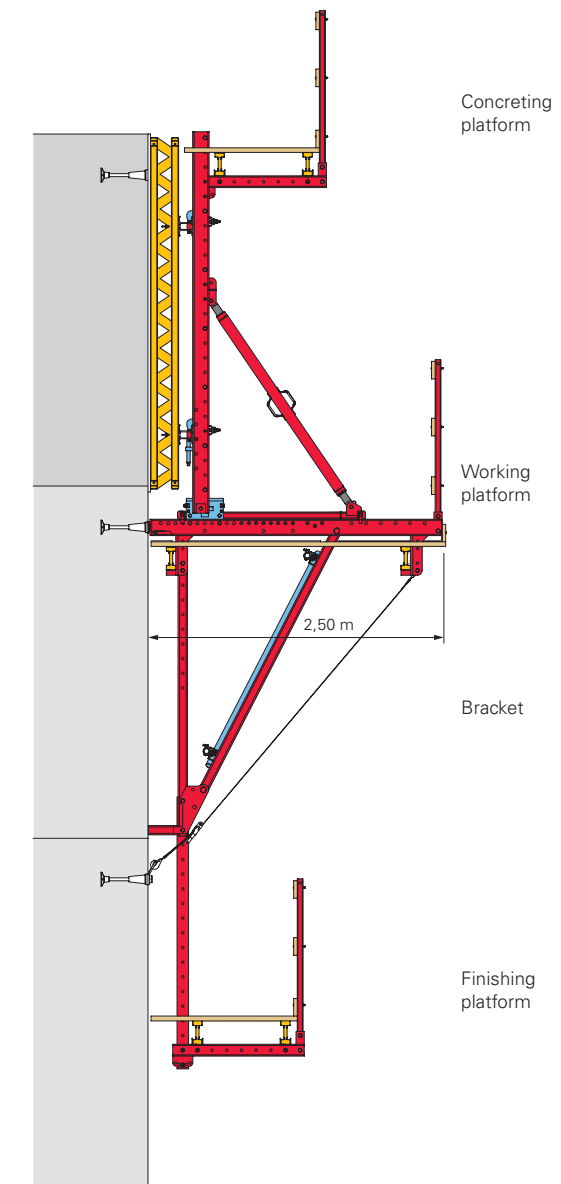

SCS Starter Brace Frame

Modular construction consisting of strongbacks, heavy-duty spindles and starter walers

For the first casting segment, a starter brace frame is used while diagonal anchoring transfers the loads into the bottom slab.

The SCS Starter Brace Frame is designed in such a way that the strongback, spindle and formwork can also be used in the next casting segments with the climbing bracket.

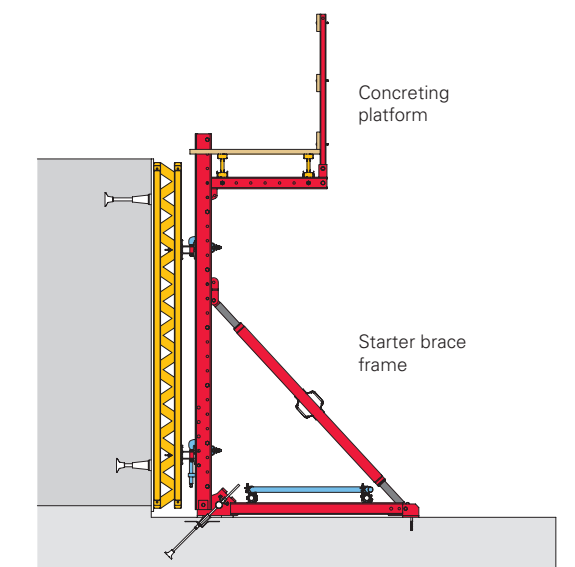

SCS two-sided application

Use of the SCS Climbing Bracket for anchored formwork with only a minimum of additional components

With only a minimum of additional components, the SCS Climbing Bracket can also be used for anchored wall formwork up to 6.00 m high. This ensures increased material utilization of the system components and thus enhanced cost-effectiveness of the investment.

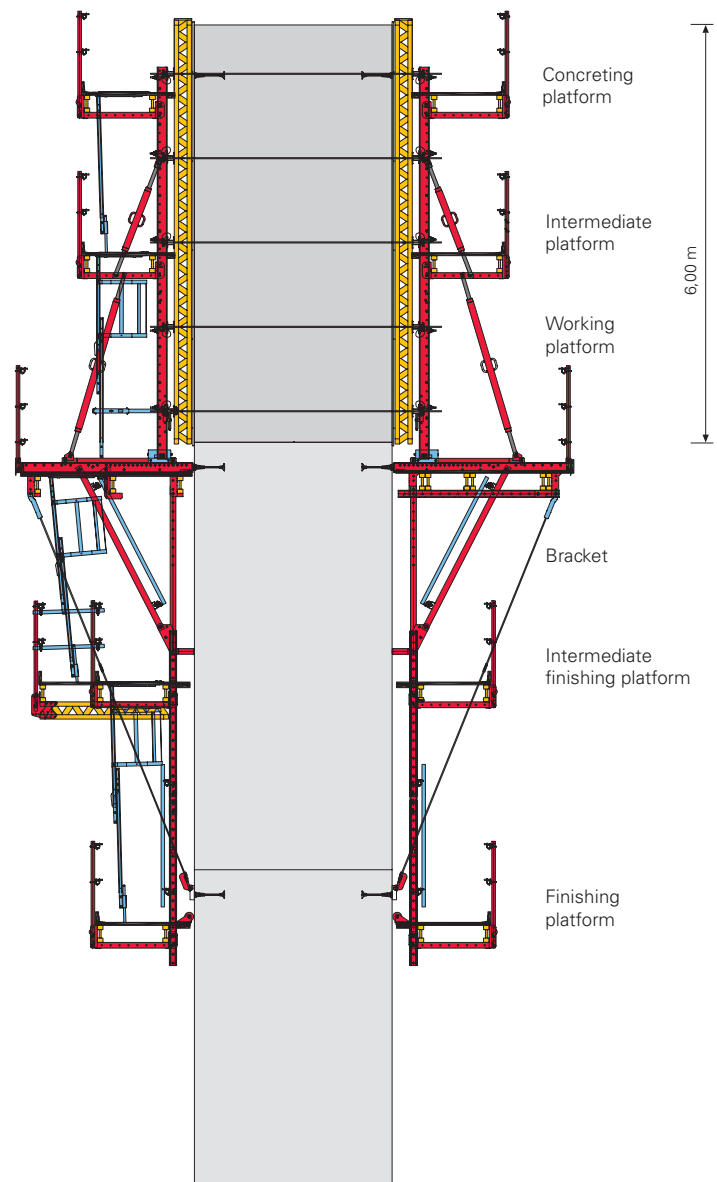

Large, craneable climbing units

Particularly high load-bearing capacity of the brackets with good utilization of the anchoring

The SCS Climbing System stands out in particular due to a high load-bearing capacity; at the same time, it is one of the lightest systems in its class. Due to the possibility of forming large climbing units – optimized for a formwork height of 3.00 m – the system is very economical.

With the SCS system, the load-bearing capacity of the brackets and anchorage are perfectly matched to one another. Through the maximum utilization of the anchoring, the number of brackets required is reduced. As a result, only few anchor points are needed. This reduces costs – also due to the reduced number of lost components. Depending on the size of the platforms, timbers or VT 20K or GT 24 formwork girders are used as the platform beams.



The moving process

For moving the climbing units by crane, the formwork is tilted backwards slightly.

The climbing unit is then released and removed from the mounting rings or mounting bolts, and then lifted.

The cross beam is subsequently mounted on the next highest mounting rings or mounting bolts, and then secured.

After this, the crane lifting gear can be released. Following this, the leading anchor for the next casting segment is fixed to the formwork.

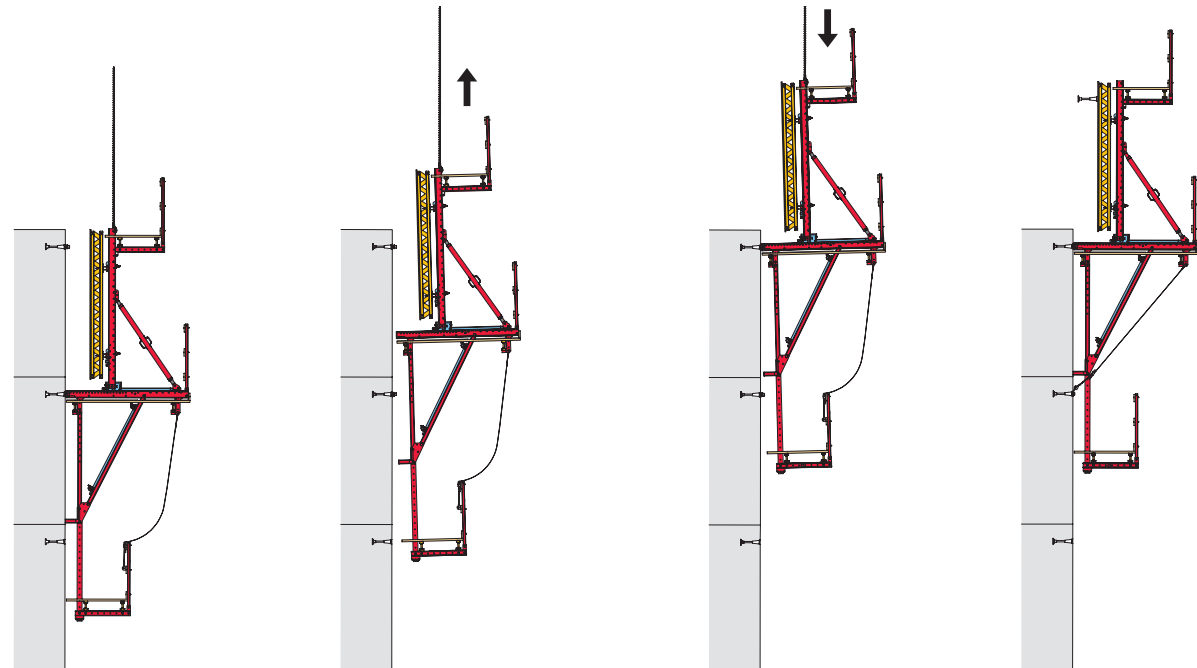



Proven tie system with the certified PERI Climbing Cone

The anchoring is approved by the building inspection authority. The suspension systems have been optimally adapted for this application and are therefore particularly cost-effective. The PERI portfolio includes:

- Mounting Bolt SCS for high tensile forces
- Mounting Ring SCS for high vertical loads
- Climbing Cone M30 / DW 20
- Climbing Cone M36 / DW 26

Climbing Cone M30 / DW 20

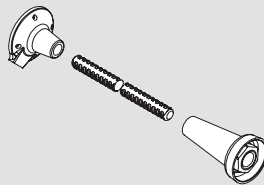

Climbing Cone M36 / DW 26

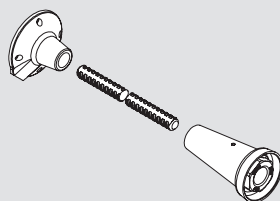

Mounting Ring SCS M30

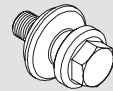

Mounting Bolt SCS M36

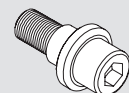

Mounting Ring SCS M36

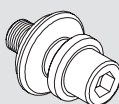

Material-optimized solution

Same formwork and components for the starter and subsequent standard cycles



With the so-called starter cycle, the loads are transferred into the bottom slab. This cycle frequently has to be carried out with varying heights, e.g. with uneven ground surfaces. Only one additional component is required for the SCS: the Starter Bar SCS.

The starter bar transfers the loads from the first concreting section into the bottom slab. For subsequent cycles, strongbacks, spindles and the form-

work are simply mounted on the brackets and re-used without requiring any modifications.

In general, the SCS Climbing System follows a modular concept; in addition, all system components are consistently designed to accommodate a system grid of 125 mm – as with the VARIOKIT Engineering Construction Kit. This ensures maximum material utilization of the components resulting in a high level of cost-effectiveness.

Thus, for example, the climbing bracket consists of multiple parts so that most of the same components are used for both the SCS 190 and SCS 250. The adjusting unit as well as the separate vertical and diagonal struts are used in both system versions. Last but not least, the SCS 190 and SCS 250 utilize identical system components for the formwork support and for the finishing and concreting platforms.



SCS system components are used for the vertical starter with brace frames: Starter Bar SCS, Strongback SCS and the Heavy-Duty Spindle SCS.

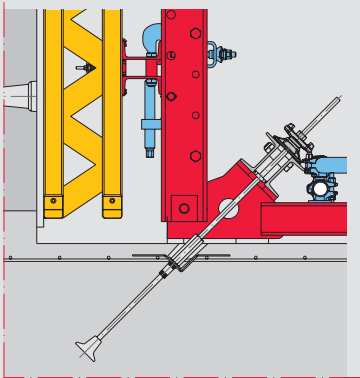

For anchoring the starter brace frames, an SRU Waler together with tie rod and wingnut pivot plate can be used.

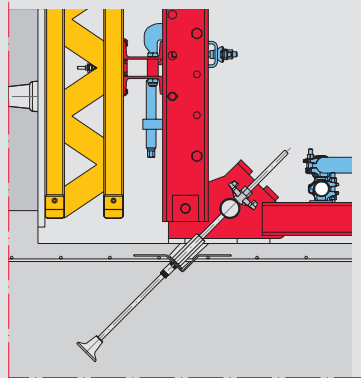

The alternative anchoring solution consists of tie yokes and wingnuts.

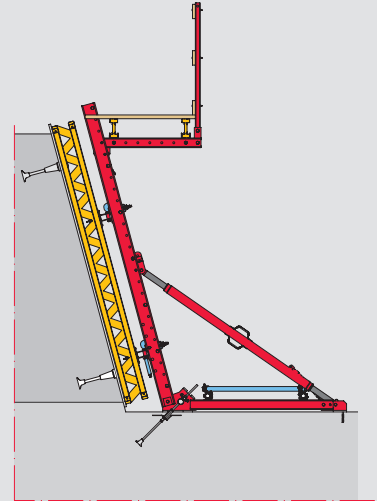

With SCS, inclined starters can also be realized as the inclination of the wall is adjusted using the heavy-duty spindle.

The SCS Climbing System includes easy and simple solutions for different starter heights which facilitates use in difficult terrains.

**Starter height
1.20 m – 2.00 m**

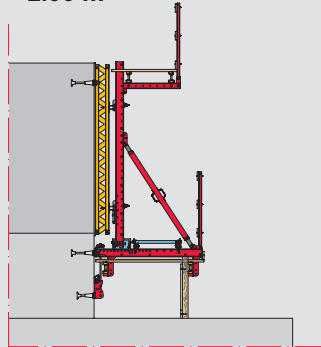

**Starter height
2.00 m – 2.50 m**

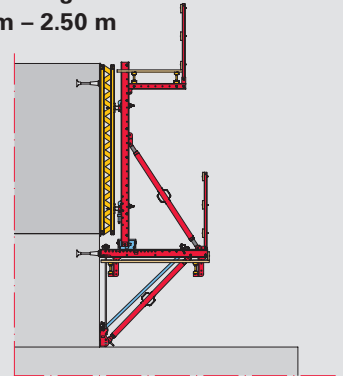

**Starter height
2.50 m – 2.80 m**

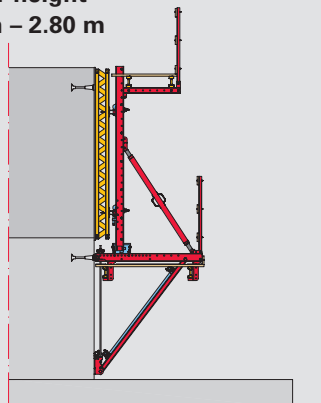

**Starter height
2.80 m – 3.00 m**

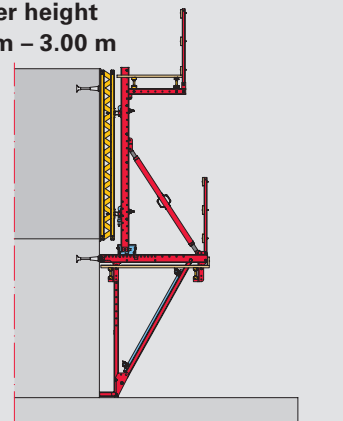

Safe, horizontal working areas

With inclinable platforms which can easily be adapted to suit inclined structural elements



SCS is very flexible and safe to use. The platforms themselves can be aligned horizontally even during inclined working operations. In addition, 1.50 m high guardrails installed on the working platforms provide a high level of work safety.

For dams and other similar structures which are realized using single-sided forming operations, inclined areas very often need to be constructed. The SCS Climbing System provides the appropriate flexibility in order that these surfaces can also be efficiently and safely formed.

Thus, the length of the platform suspension for the working platform can be adapted according to the respective component inclination; the working platform is therefore always aligned horizontally. Furthermore, concreting and finishing platforms can be tilted by $\pm 15^\circ$ as well as $\pm 30^\circ$ so that these working areas are also horizontally positioned in all situations. In addition, the generously-sized 1.50 m high guardrail posts guarantee a high level of safety on all platforms.



For inclined applications, working, concreting and finishing platforms are adapted to accommodate different inclinations; the angle of inclination can be changed easily. With these inclined components, concreting loads are also reliably transferred via the anchoring into the respective preceding casting segment.

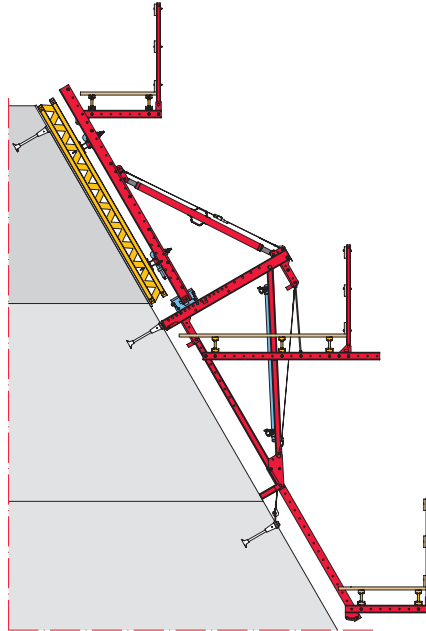

Execution featuring a component with a forward inclination of up to 30°.

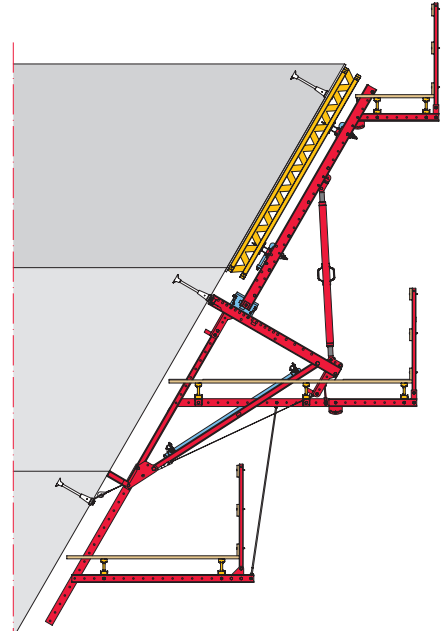

Execution featuring a component with a rear inclination of up to 30°.

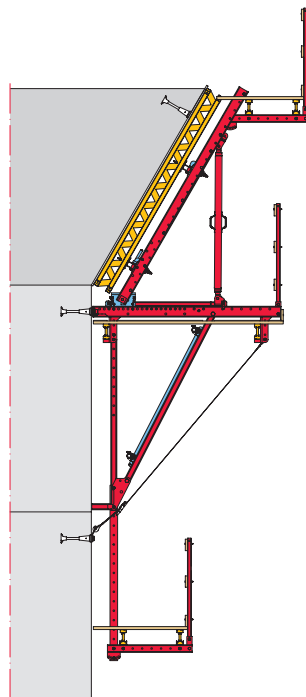

Execution featuring changes in inclination to the rear of up to 30°.

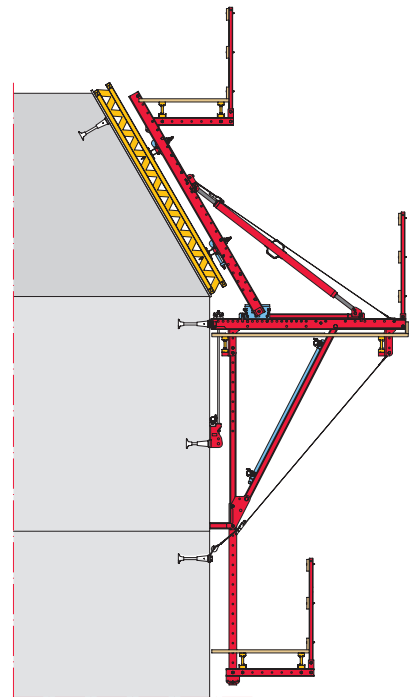

Execution featuring changes in forward inclination of up to 30°.

Also suitable for two-sided applications

A minimum of additional components provide a high level of material utilization and reduced logistical requirements

With only a minimum of additional components, the proven SCS Climbing Brackets can also be used for two-sided applications.

With anchored wall formwork, the SCS Brackets can be used up to heights of 4.00 m (with SCS 190); with an additional 5.50 m long strongback, heights of up to 6.00 m are possible. If required, an intermediate platform and an intermediate finishing platform can be mounted on the formwork.

Compared to single-sided applications, larger platform widths and therefore wider climbing units can be realized with anchored wall formwork. As a result, centre beams are arranged under the platform lining and reinforced platform beams are used for the concreting, intermediate and finishing platforms. Double use of platform posts from the single-sided application facilitate the suspension of the finishing platform. In addition, scaffold tubes are to be installed to brace the finishing platform suspension.

Thanks to its compatibility with the VARIOKIT Engineering Construction Kit, project-specific solutions using system components from the PERI rental park can also be realized – without requiring any investment in customized special components.

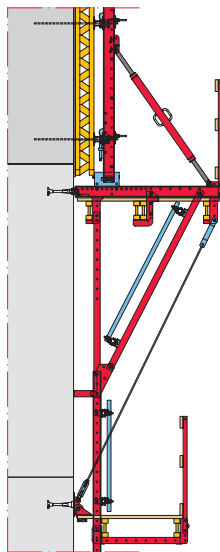

The centre beam can be supported on the Girder Support RCS – if formwork girders are used here in standard lengths.

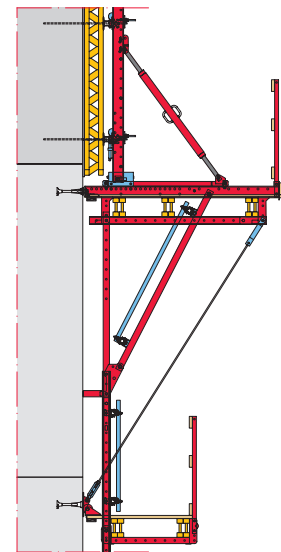

If the platform width has an intermediate dimension or a continuous adjustment of the platform width is required, the Guardrail Post RCS 226 is used as a support. The girders can then be arranged in an overlapping formation.

The high load-bearing capacity of the brackets also allows wide climbing units for two-sided applications to accommodate large formwork heights and high wind loads. The advantages are reduced material requirements, fewer lost components as well as less crane requirements and work effort.



SCS Platforms can be delivered to the construction site already pre-assembled; the final assembly steps are carried out on the horizontally-positioned elements.

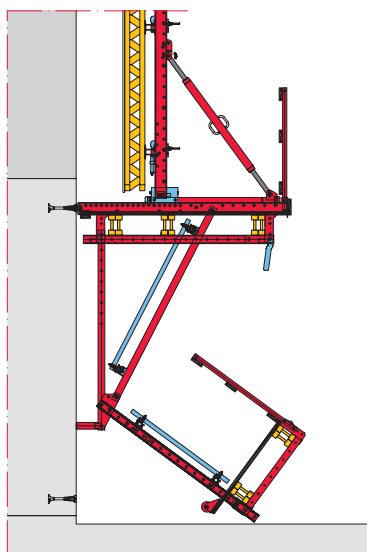

While the climbing bracket is being fixed to the wall, the finishing platform is mounted to it. When moving the unit, the finishing platform then swings into a vertical position. This means that remaining under suspended loads is not necessary at any time.

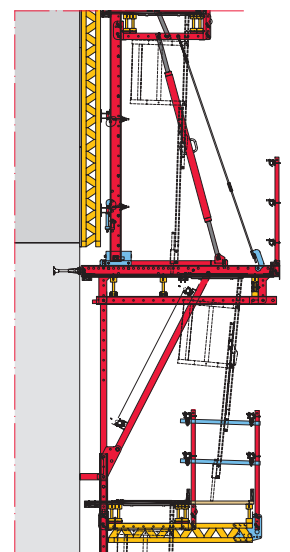

Accessing the finishing platform via the ladder is safe at all times – even with retracted formwork. For descending from the working platform to the finishing platform, a cantilevered ladder platform can be integrated.

The SCS Climbing System at a glance

Regular operating sequence, standard applications and execution details

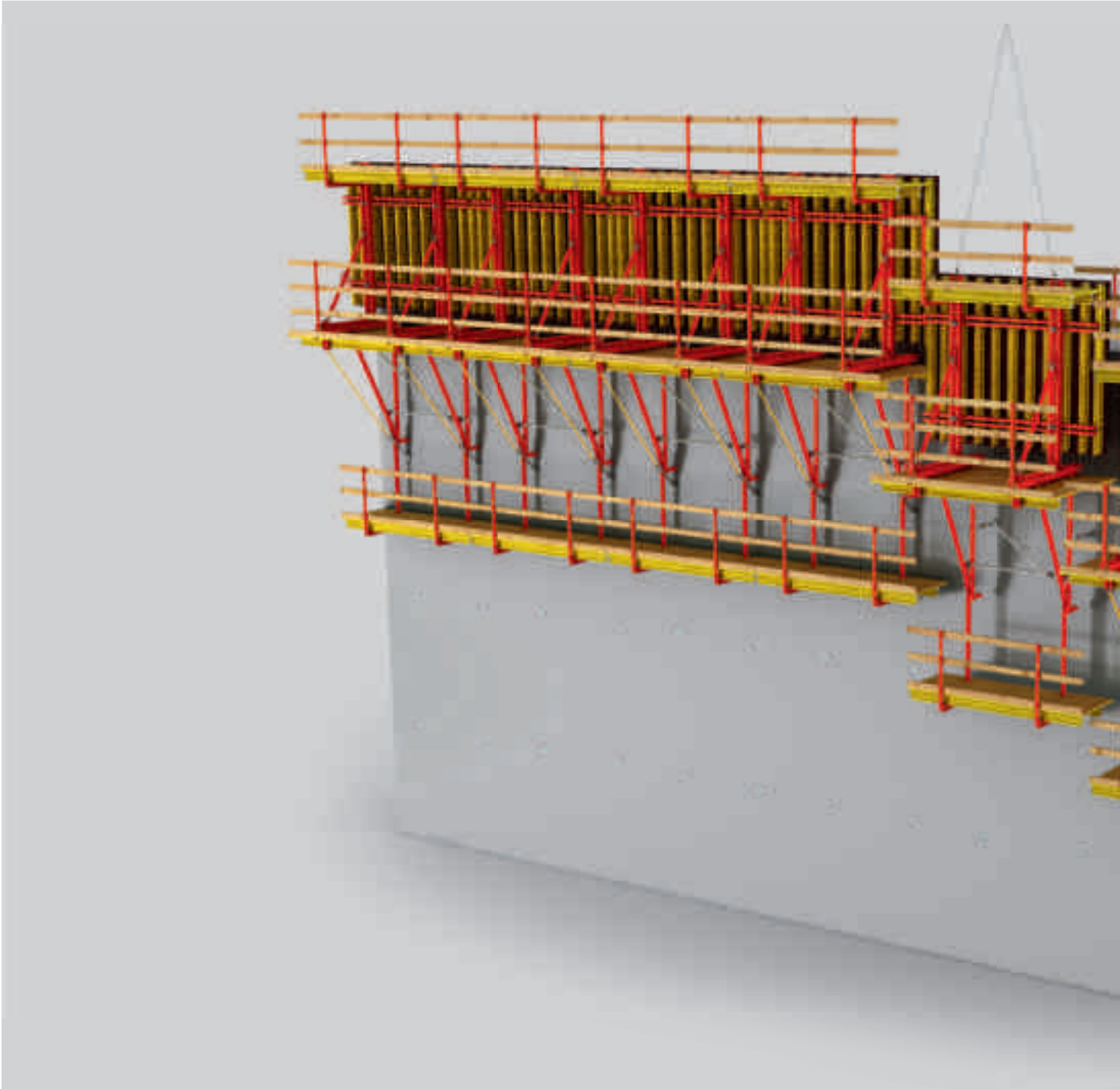

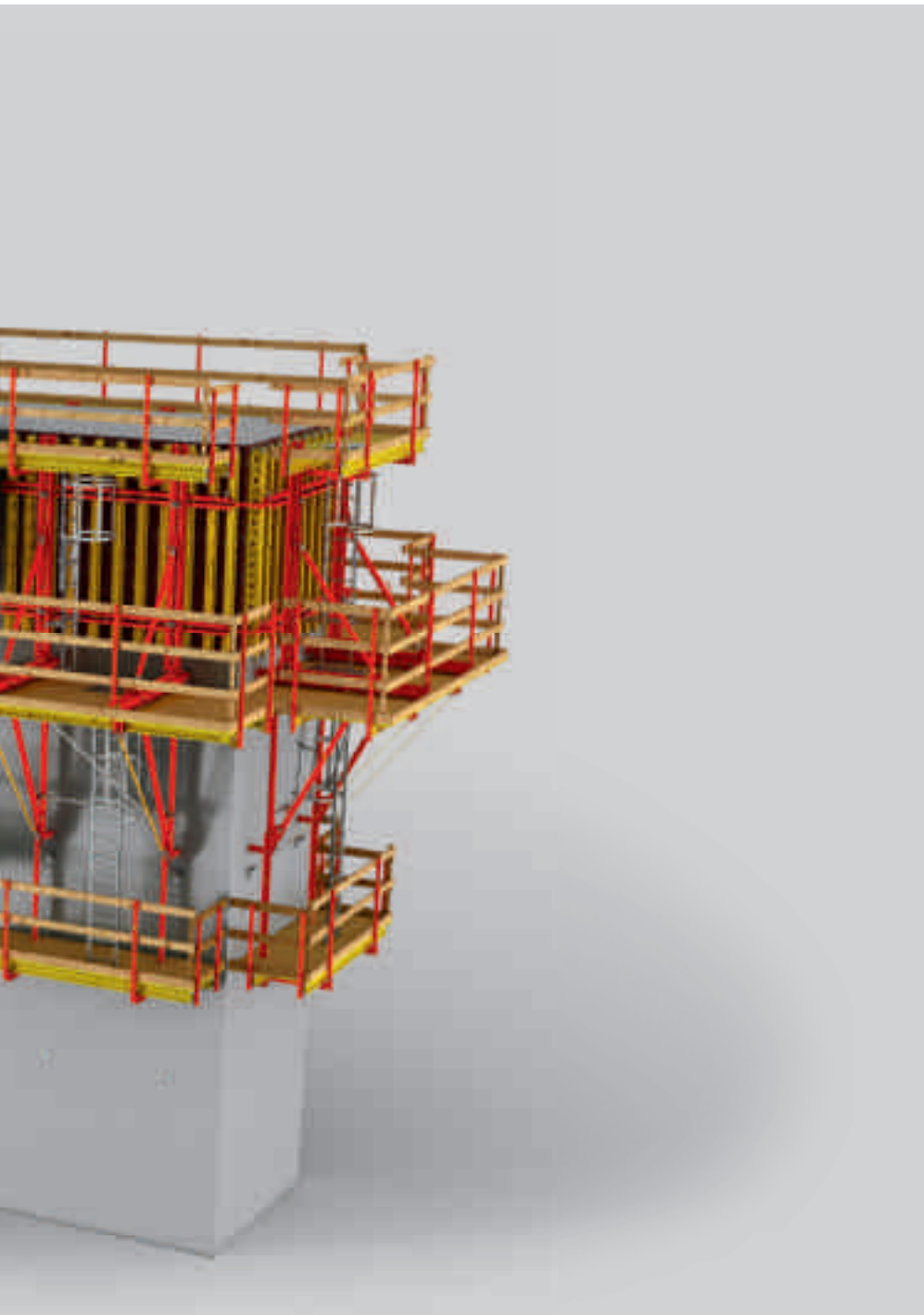

The assembly of the SCS Climbing System shows the three platforms: concreting, working and finishing platform.

The top platform – the concreting platform – is used for placing the concrete, for attaching the crane slings and for mounting the leading anchor.

The formwork is adjusted and operated, e.g. retracted, from the middle working platform.

The finishing platform suspended at the bottom is used to recover the anchor from the preceding casting segment and, if necessary, for mounting the wind safety device. If required, the finishing platform can also form the necessary working area for post-processing the concrete.

The regular operating sequence with SCS

Simple cycle sequence for fast construction progress

The starter cycle

The first casting segment is constructed using the starter brace frame. In the process, the horizontal starter bar is anchored in the bottom slab and, together with the formwork, complements the strongback and the heavy-duty spindle. The last-mentioned components can be re-used during subsequent use with the climbing bracket.

The first climbing step

For the second casting segment, the climbing bracket is used without a finishing platform. Formwork, strongback and spindle of the starter are mounted on the bracket.

Striking

Striking is carried out with the help of the spindle, adjusting unit and formwork carriage. To do so, first release the mounting for the leading anchor after the concrete has hardened. The mounting ring must subsequently be fixed to the embedded leading anchor to which the climbing unit is later attached. Any wind safety devices are to be detached, anchors which are no longer required must be removed and anchor holes are to be sealed with plugs.

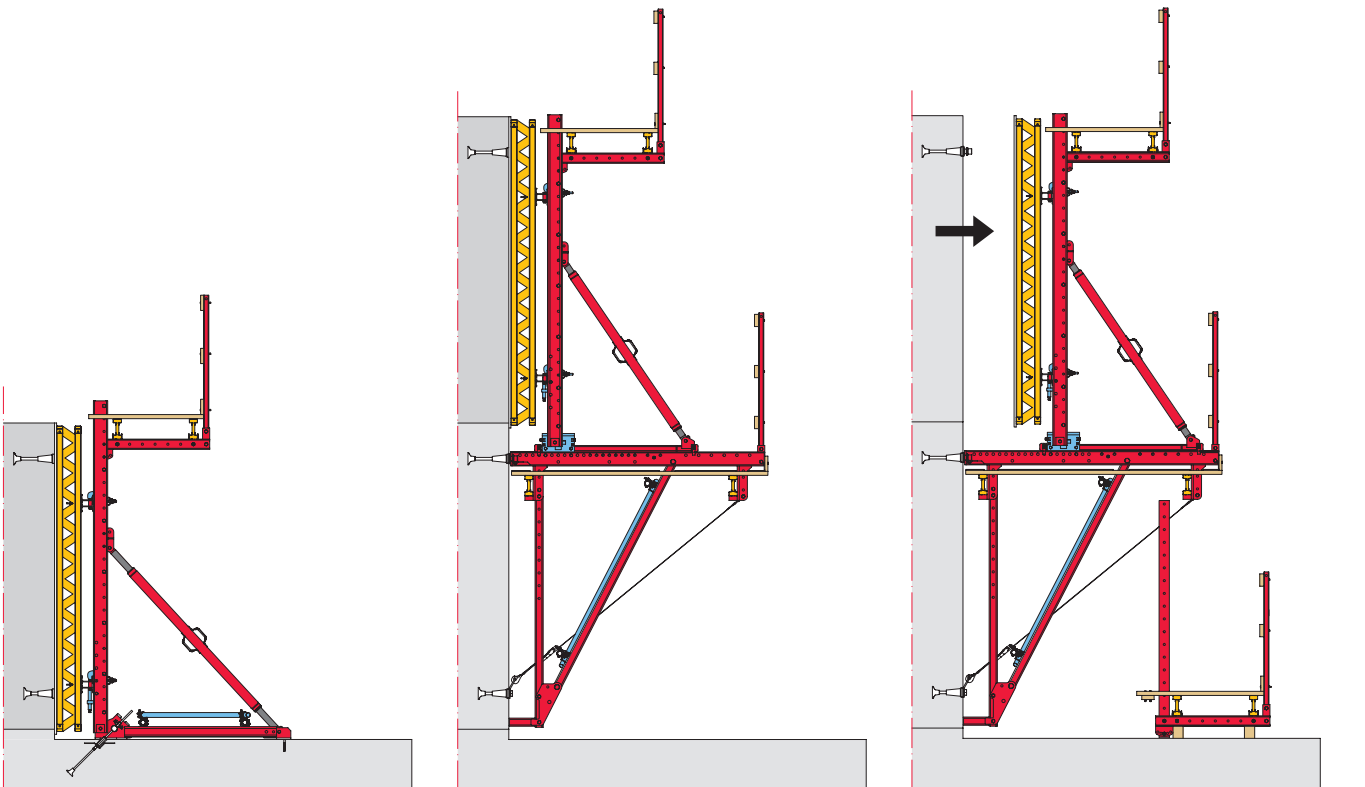

Moving procedure

After striking, the climbing unit is prepared for the moving procedure. Crane hooks are to be attached to the strongbacks of the climbing unit, and the locking pins of the bracket are released. The finishing platform is subsequently mounted.

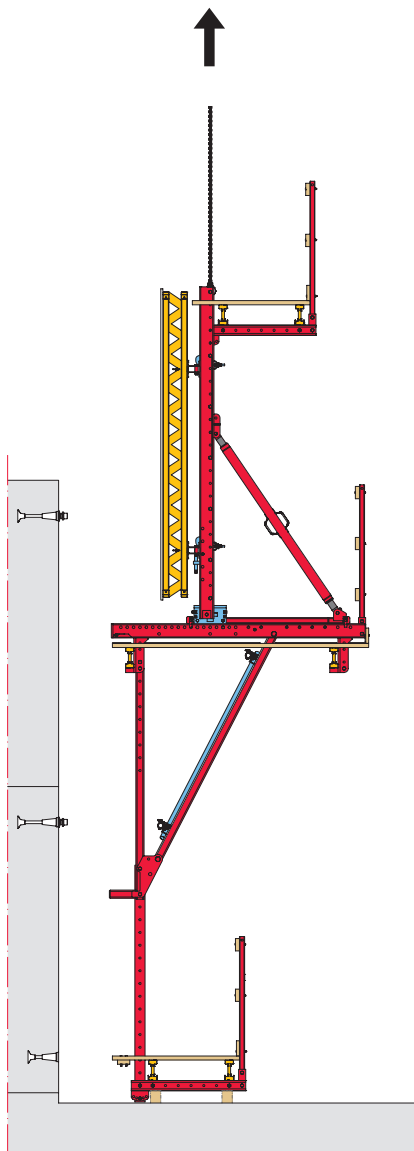

Climbing in standard cycles

The climbing unit is lifted using the crane and attached to the next highest anchoring. The locking pins secure the brackets against lift-off; if necessary, a wind safety device can be installed.

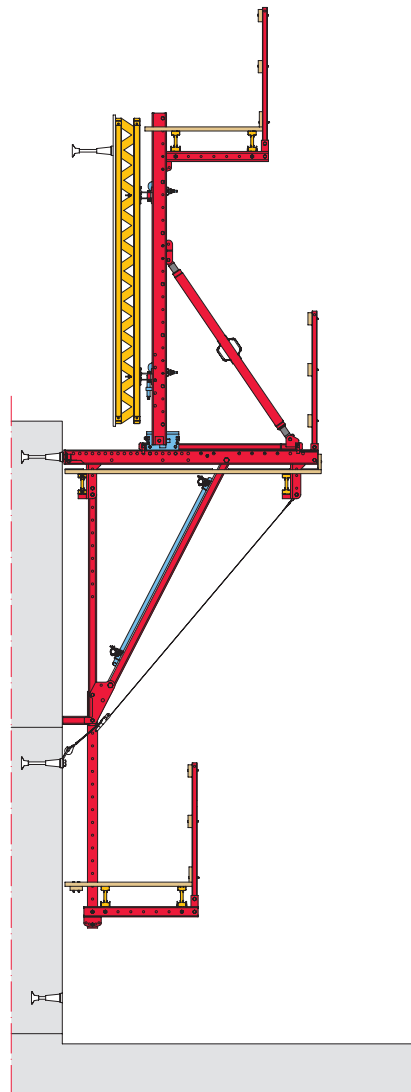

Shuttering

The formwork must be cleaned before each subsequent concreting cycle while the leading anchors are attached to the formwork. The formwork is set up in the concreting position by means of the carriage and adjusting unit, and then adjusted using the height adjusting unit and spindle. The first standard cycle is then concreted.

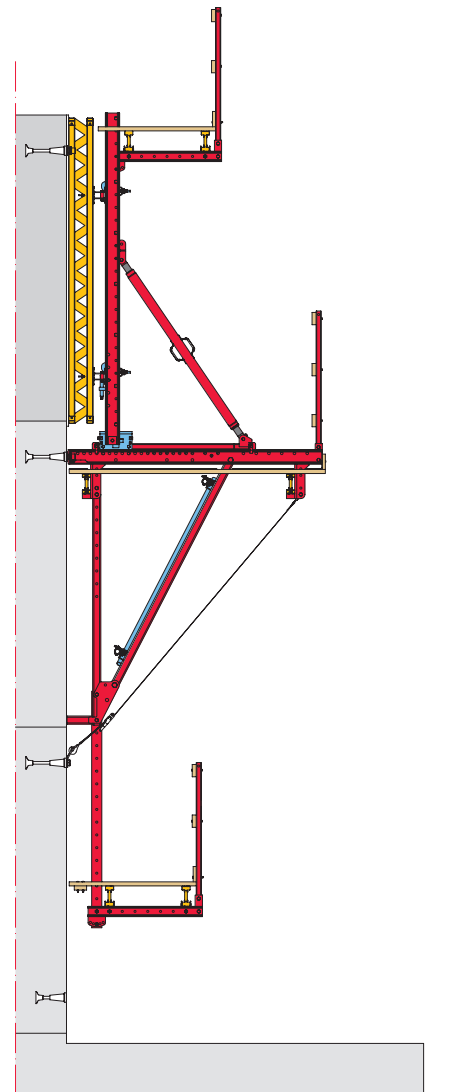

Execution details

Simple and exact formwork adjustment

For exact adjustment of the formwork, SCS offers a high level of flexibility; it can be easily and quickly adapted both vertically and horizontally as well as in inclined positions.

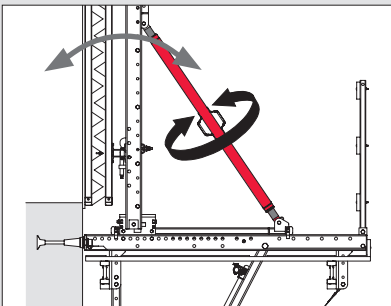

By turning the heavy-duty spindle, the required formwork inclination can be adjusted.

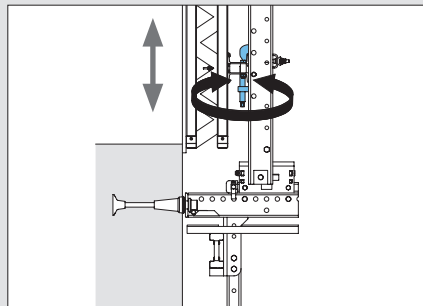

The formwork is vertically aligned by means of the adjusting screw on the height adjusting unit.

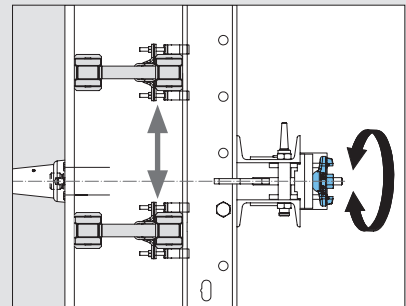

After opening the waler fixation, the formwork can be horizontally aligned.

Closing the formwork with the adjusting unit

The Adjusting Unit SCS allows controlled pressing of the formwork against the previous casting segment. It is used for the cross beam unit of the SCS 190 as well as the SCS 250 with formwork carriage. The adjustment range is ± 45 mm.

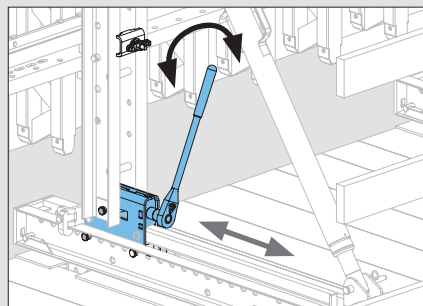

The adjusting unit is operated quickly and easily with the ratchet wrench.

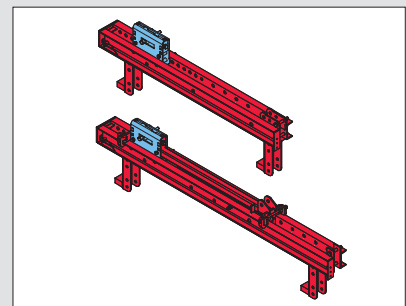

The adjusting unit is used for the SCS 190 version as well as for the SCS 250 with formwork carriage. This helps to minimize the number of different system components.

Protection against lifting

A locking pin fixes the bracket in order to prevent lifting; the carriage of the SCS 250 is also secured against lifting during the moving procedure.

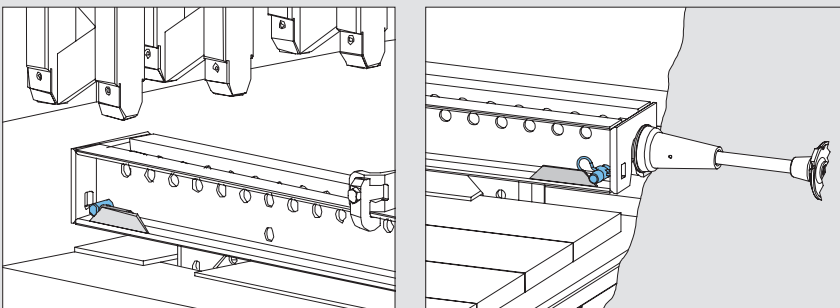

Simplified logistics and space-saving transport

The modular design of the bracket consisting of cross beam, vertical and diagonal struts results in only small space requirements for transport and storage. The platforms can be transported already pre-assembled, and then quickly and efficiently mounted on the construction site.



The SCS Climbing System in use



The Panama Canal has connected the Atlantic and Pacific Oceans since 1914 and is one of the most important waterways: a total of 6% of the cargo shipped worldwide is transported through the Panama Canal. From 2011 to 2014, the waterway was expanded so that it could subsequently accommodate larger container ships. Key measures were the construction of two new locks on the Atlantic and Pacific sides respectively.

From 2011 onwards, PERI delivered more than 1.100 containers filled with formwork and scaffolding materials to the construction sites. The SCS Climbing System played a major role in the overall solution.

Due to its size and complexity, the project entailed major challenges in terms of know-how, logistics and construction site support. The transnational and intercontinental cooperation involving the international team of PERI engineers, logistics experts and other specialist engineers was an essential key to the success of the project.



In numerous projects worldwide, the climbing system has proved its flexibility and cost-effectiveness time and time again. The selected application examples on the following pages feature power stations and dams as well as bridge pylons.

The SCS Climbing System in use



For the largest-ever individual contract in the company's history, PERI supplied a comprehensive overall concept and innovative climbing technology as well as delivering a very impressive performance.

Panama Canal Lock Facilities, Panama

PERI Spain and PERI Panama were responsible for the formwork planning, logistics and on-site assistance for the expansion of the Panama Canal – competently supported by PERI headquarters in Weissenhorn. PERI delivered more than 1,100 containers to the construction site.

To ensure that the tight schedule could be maintained, a total of 4,200 personnel on both jobsites processed around 6,300 m³ of concrete on a daily basis in two shifts. Within the construction period of three years, the construction site team formed an area of about 2.2 million square metres; the material used amounted to approx. 6.6 million cubic metres of concrete and 337,500 tonnes of steel. The construction site facilities included, among other things, 70 cranes and 30 concrete pumping stations. These boundary conditions required an immense outlay of formwork and scaffolding materials along with a comprehensive overall concept.

An essential element of the PERI solution was the SCS Climbing System for single-sided applications which was used for the first time on this construction site. Depending on the project requirements in the respective areas of the site, PERI engineers combined the brackets with either VARIO Girder Wall Formwork or TRIO Panel Formwork. Different shoring systems from the PERI product portfolio ensured efficient transfer of loads under the slab formwork which was carried out in part with pre-assembled slab tables. In particular, PERI UP Flex Modular Scaffolding was extremely versatile in its application as it was used for the shoring as well as the realization of safe access means.



PERI supported the construction of the impressive dam near the Portuguese town of Alijó, among other things, with an extensive range of engineering services.

Foz Tua Dam, Alijó / Vila Real, Portugal

For the construction of the Foz Tua Dam and the nearby pumped-storage power plant, PERI developed and supplied an optimized and safe formwork and scaffolding solution. With a comprehensive concept as well as logistical and technical services, PERI specialists supported the contractors – Barragem de Foz Tua, ACE – in ensuring dimensionally accurate construction work along with on-schedule completion. The close cooperation between the PERI engineers and all project participants as well as the continuous coordination provided by PERI project managers on the jobsite ensured the success of the project.

The dam wall in northern Portugal reaches a total height of 108 m while the length of the dam's crest measures 275 m. With regard to the formwork, the complex form of the double-curved reinforced concrete construction with a 5 m wide dam crest was especially challenging.

PERI engineers developed a formwork concept using the SCS Climbing System and VARIO GT 24 Girder Wall Formwork. This combination was the ideal solution for the massive dam wall as it allowed single-sided transfer of loads as well as meeting the high surface requirements.



Dam upgrade project: as part of a hydroelectric power plant expansion in Alaska, the height of the dam wall was to be increased.

Blue Lake Dam, Sitka / Alaska, United States of America

The Blue Lake Dam Project in Alaska centred on expanding the existing dam. The dam supplies electricity to the city of Sitka in the north-west of the United States. Among other things, new intake structures and penstocks along with lock gates were realized. In addition, the height of the existing arch dam wall was to be increased by around 27 m. After completion of the project, the hydroelectric power plant now generates 27 % more electricity which further supports the city's energy independence.

Different PERI systems were used for constructing the various structures of this large-scale project. The SCS Climbing System was used for realizing the massive arch of the new dam crest. The project-specific planning solution combined the brackets with VARIO GT 24 Girder Wall Formwork.



The massive power plant walls were single-sidedly formed and concreted using the SCS Climbing System.

Smithland Hydroelectric Power Plant, Smithland / Kentucky, United States of America

For the Smithland hydroelectric power plant, PERI supplied a customized formwork and shoring solution. The extremely tight construction time, massive components and in part multi-curved shapes required not only large quantities of system equipment but also countless, specially designed 3D formwork units. With a comprehensive concept, the PERI specialists supported the construction company in ensuring efficient and dimensionally accurate execution carried out on schedule. These included close, transnational cooperation between PERI engineers, prefabrication of the formwork elements as well as the on-going coordination by a PERI project manager on the construction site.

A large part of the massive walls were realized with the SCS Climbing System – as a result, no anchors were required. As this formwork solution avoided any costly sealing work, this meant that large savings could be made regarding the time and costs required for the construction work. Thanks to the particularly high load-bearing brackets as well as the best utilization of the anchoring, large climbing units were also possible which further accelerated construction progress.

The SCS Climbing System in use

Xayaburi Hydroelectric Power Station, Laos

Around 30 km to the east of the provincial capital Xayaburi, a dam complete with a hydroelectric power station was built on the Mekong river in northern Laos. It is the first structure of a total of 11 dams which have been planned for the lower Mekong Basin. With a nominal output of 1,260 megawatts, the Xayaburi hydroelectric power station is, in this respect, the third largest project in the overall planning. A shipping lock and two fishways were also planned.

The dam wall is 820 m long and has a total height of 49 m whereby the water level has been raised by 32 m. For realizing the reinforced concrete work, PERI designed and supplied a formwork solution based on the SCS Climbing System. In particular, the flexibility of the system was very important for ensuring the smooth execution of the construction work in order to form the variable geometry. In addition to the straight dividing walls, there were also many areas of the dam to be constructed with rounded shapes. Along with the planning solution, providing training to the construction team was also a large part of the PERI support for ensuring the successful execution.



The high flexibility of the SCS Climbing System allowed an easy adaptation to suit all geometries in this dam project.

Bagatelle Dam, Port Louis, Mauritius

The Bagatelle dam project has improved the water supply on the small island state by increasing the storage capacity by approx. 14 million cubic metres. After the project was completed, a 2.5 km long and up to 48 m high dam transformed a tributary of the Grand River North West into a reservoir 400 m above sea level. Construction of the overflow funnel for the flood spillway was realized with a 3D formwork solution. The diameter of the circular shaft construction featured in the ground plan widens in the upper area from 8 m to 27 m in the form of a chalice – externally with a uniform and internally with variable inclinations respectively.



Freeform formwork on SCS Climbing Brackets for a large-sized concrete funnel.

For the construction of this complex geometry, the three-dimensional formwork units on the basis of VARIO GT 24 Girder Wall Formwork elements together with SCS Climbing Brackets were combined to form craneable climbing units. With the SCS Climbing System, the forward and reverse-inclined sections could be concreted without ties. The adaptation to suit the complex geometry was no problem; in addition, the bracket platforms always ensured horizontal working areas and access points even when having to deal with differently inclined walls. The formwork for the funnel walls with curved surfaces on all sides was individually manufactured and realized in the PERI formwork assembly facility.

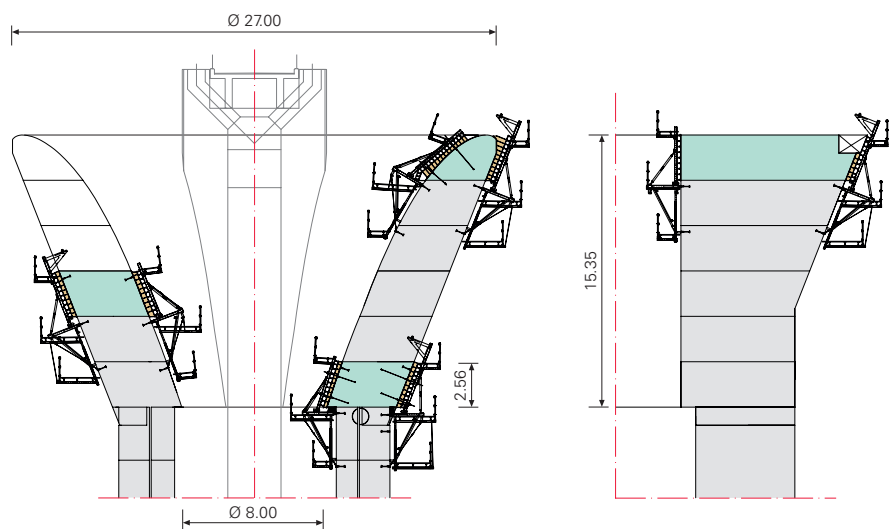

The SCS Climbing System could be flexibly adapted to suit the variable inclinations and reliably transferred the high loads from the fresh concrete pressure into the previous casting segment.

The SCS Climbing System in use

Ruhrtal Bridge Bermecke, Nuttlar, Germany

In the Hochsauerland region, a steel composite bridge with a length of 626 m and span of 64 m has been constructed whereby the superstructure was realized using the incremental launching method. The structure crosses the Ruhr Valley at a height of up to 50 m and forms part of the feeder route to the Nuttlar junction on the A 46 motorway.

The superstructure – featuring 10 sections ranging from just under 50 m up to a 65 m individual spans – has a circularly-curved ground plan. The composite cross-section consists of an upwardly open, trapezoidal hollow-box girder made of steel as well as an unstressed concrete carriageway.

The SCS Climbing System was used for constructing the massive pier heads.



The SCS provided the optimum solution for the heads of these reinforced concrete piers for the composite bridge.

Mahatma Gandhi Mandir, Gandhinagar, India

The Mahatma Gandhi Mandir is not only a convention centre but also a memorial site in Gandhinagar, Gujarat. The architecture of the complex was inspired by the life and philosophy of Mahatma Gandhi. With a surface area approaching 1.4 hectares, the complex has a total size of more than 19 football pitches.

The facility also features a cable-stayed bridge for pedestrians which connects the museum to the congress centre. The pylon of the bridge has a 15° inclination and could not be realized with anchored formwork due to its massive dimensions. For this reason, PERI India planned and supplied a formwork solution based on the SCS Climbing System. The SCS 250 version with formwork carriage was used whereby the formwork could be retracted by 62 cm for carrying out the reinforcement work as well as installation of the anchors.



Spacious and safe working areas on all 3 levels.

Item no.	Weight kg
118737	140.000

Crossbeam Unit SCS 250

Platform Beam for single-sided climbing brackets with Adjusting Unit SCS and Carriage SCS to work in front of the formwork.

Complete with

- 1 pc. 118690 Carriage SCS
- 1 pc. 118575 Adjusting Unit SCS
- 2 pc. 104477 Bolt ISO 4014 M20 x 120-8.8, galv.
- 2 pc. 781053 Nut ISO 7042 M20-8, galv.
- 1 pc. 123692 Pin Ø 25 x 200 SCS
- 1 pc. 022230 Cotter Pin 5/1, galv.

Note

Wrench Size Carriage SW 19,
Height Adjusting Unit SW 30.

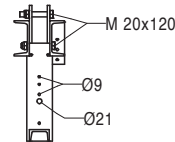
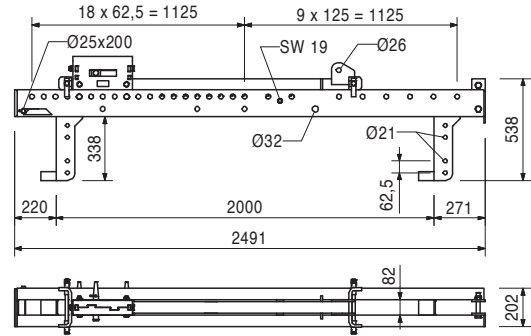
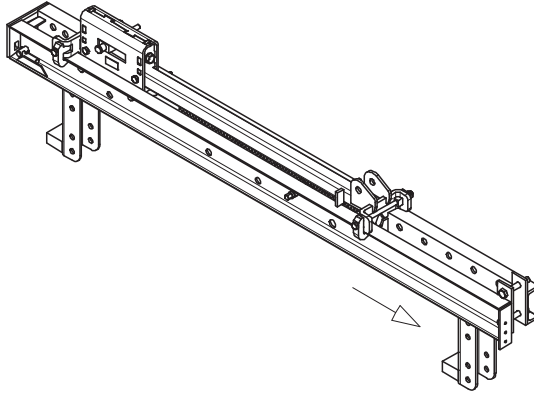

Accessories

118710	45.800
118714	40.600
118579	6.280

- Vertical Strut SCS 237**
- Diagonal Strut SCS 257**
- Guardrail Post SCS 150**

Item no.	Weight kg
118730	96.700

Crossbeam Unit SCS 190

Platform Beam for single-sided climbing brackets with Adjusting Unit SCS to prevent tipping of the formwork.

Complete with

- 1 pc. 118575 Adjusting Unit SCS
- 2 pc. 104477 Bolt ISO 4014 M20 x 120-8.8, galv.
- 2 pc. 781053 Nut ISO 7042 M20-8, galv.
- 1 pc. 123692 Pin Ø 25 x 200 SCS
- 1 pc. 022230 Cotter Pin 5/1, galv.

Note

Wrench Size Height Adjusting Unit SW 30.

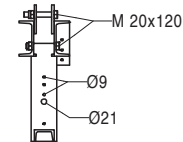
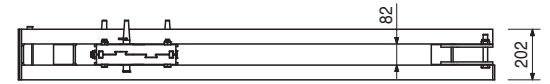
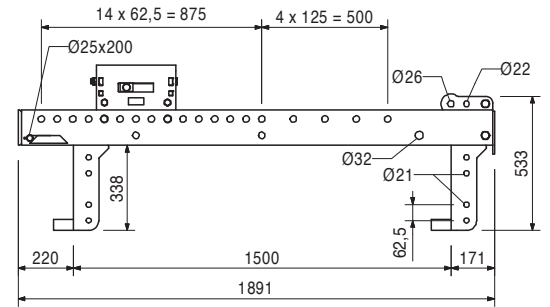
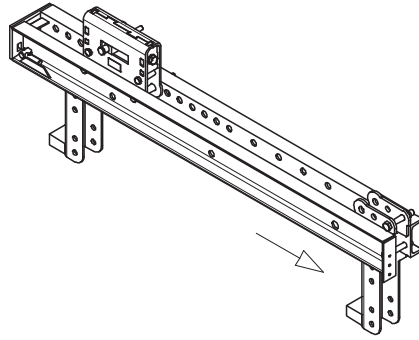

Accessories

118710	45.800
118714	40.600
118579	6.280

Vertical Strut SCS 237

Diagonal Strut SCS 257

Guardrail Post SCS 150

118710	45.800
--------	--------

Vertical Strut SCS 237

Vertical tension strut of the climbing bracket for support heights of 2.58 m and 2.40 m.

Complete with

- 4 pc. 711078 Bolt ISO 4014 M20 x 130-8.8, galv.
- 4 pc. 781053 Nut ISO 7042 M20-8, galv.

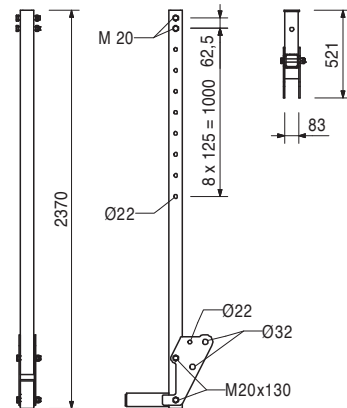
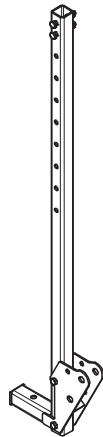

Item no.	Weight kg
118714	40.600

Diagonal Strut SCS 257

Diagonal compression strut of the climbing bracket.

Complete with

- 2 pc. 017040 Screw-On Coupler AK 48, galv.
- 2 pc. 125999 Hex Bolt M30 x 140-8.8, galv.
- 2 pc. 725119 Nut ISO 7042 M30-8, galv.

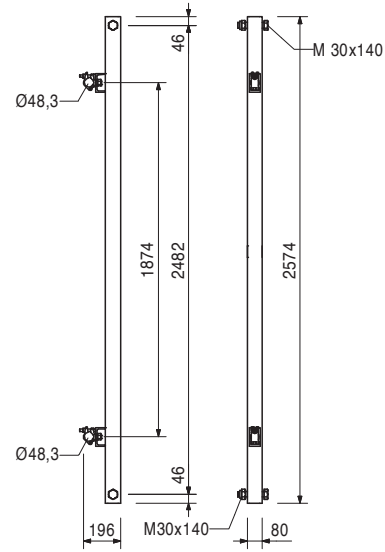
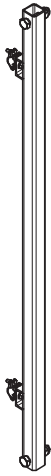

118579	6.280
--------	-------

Guardrail Post SCS 150

Guardrail post to connect handrail boards and toeboards.

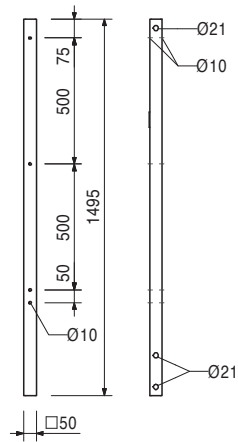

Item no.	Weight kg
118578	23.900

Platform Post SCS 232

Rigidly suspension of the Finishing Platform SCS with Platform Beam SCS for single-sided application or use as Platform Beam for inclined working platforms.

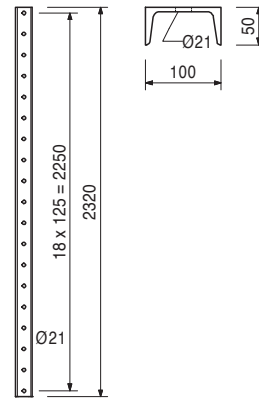

Accessories

123664	2.520
--------	-------

Connection Plate SCS Ø 21-125

118583	15.100
--------	--------

Platform Beam SCS 112

Platform beam for the finishing and concreting platform for single-sided application. Inclination can be adjusted.

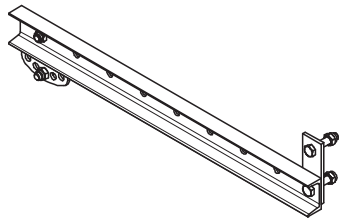

Complete with

2 pc. 113546 Bolt ISO 4017 M20 x 45-8.8, galv.
2 pc. 710226 Bolt ISO 4014 M20 x 90-8.8, galv.
4 pc. 781053 Nut ISO 7042 M20-8, galv.

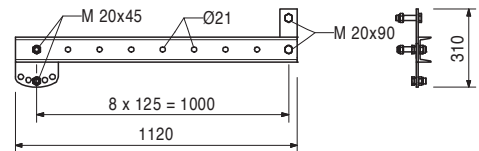

Accessories

118579	6.280
--------	-------

Guardrail Post SCS 150

118799	51.300
--------	--------

Starter Bar SCS 187

Basic bar for the erection of a brace frame for the starter.

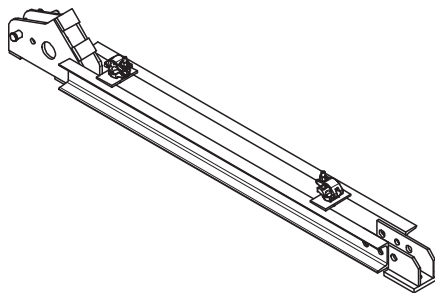

Complete with

2 pc. 017040 Screw-On Coupler AK 48, galv.
1 pc. 111567 Fitting Pin Ø 26 x 120
1 pc. 022230 Cotter Pin 5/1, galv.

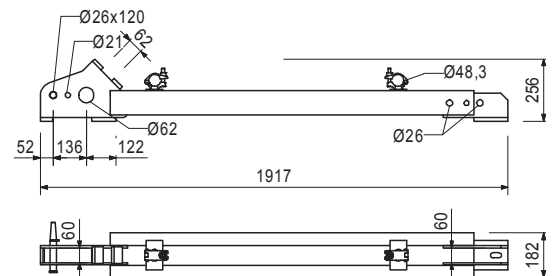

Item no.	Weight kg
123828	2.430

Spindle Adapter SCS Ø 26/31

For connection of Heavy Duty Spindles SCS to Climbing Rails RCS, Crossbeam SCS or Bracing Shoe SCS M36/DW 20.

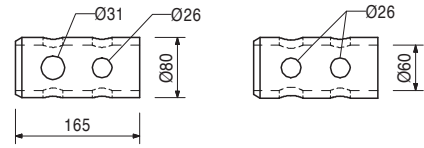
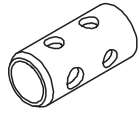

051030	5.320
--------	-------

Height Adjusting Unit CB, SCS

For height adjustment of VARIO GT 24 panels on the Strongbacks CB and SCS.

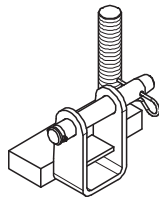

Complete with

1 pc. 715936 Pin Ø 25 x 180, incl. dowel pin Ø 6
1 pc. 018060 Cotter Pin 4/1, galv.

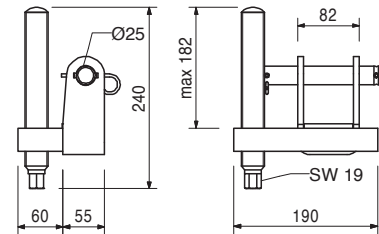

129689	6.750
--------	-------

Height Adjusting Unit-2 CB/SCS/RCS

For height adjustment of RUNDFLEX panels on the Strongbacks CB/RCS/SCS.

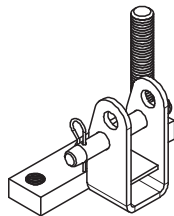

Complete with

1 pc. 715936 Pin Ø 25 x 180, incl. dowel pin Ø 6
1 pc. 018060 Cotter Pin 4/1, galv.

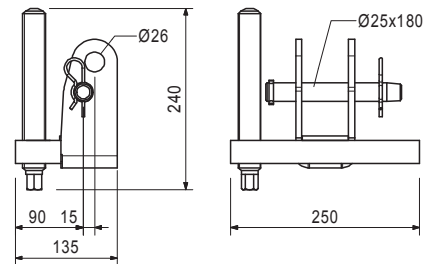

110059	2.840
--------	-------

Waler Fixation U100 – U120

For fixing VARIO GT 24 panels to Strongbacks CB, SCS and Steel Waler SRU.

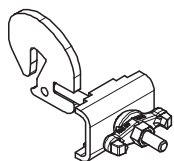

Complete with

1 pc. 110055 Cross Clamp, galv.
1 pc. 118260 Spherical Nut RD 16, galv.

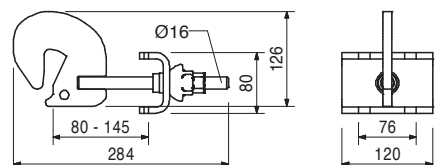

Item no.	Weight kg
129720	8.040

Waler Fixation-2 U100 – U120

For fixing VARIO GT 24 panels to strongbacks CB, SCS, Steel Waler SRU if anchoring is done through the strongback.

Complete with

2 pc. 118260 Spherical Nut RD 16, galv.

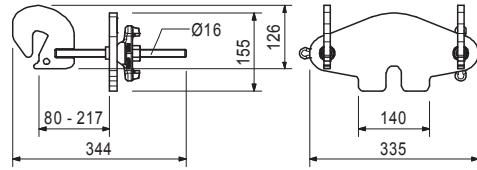
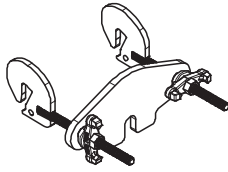

125510	5.710
--------	-------

Fixation SCS TRIO

For fixing TRIO Panel Formwork with single sided application.

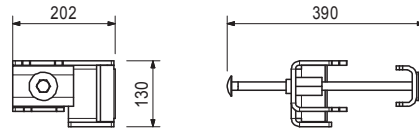
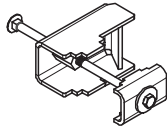

129674	178.000
--------	---------

Strongback SCS 550

Strongback for supporting the formwork for double-sided application and formwork heights up to 6.00 m.

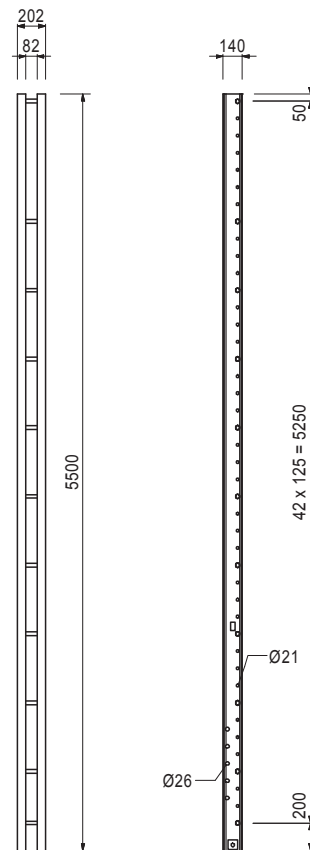

SCS Climbing System



Item no.	Weight kg
111035	12.100
101773	14.700
101774	18.200
101776	24.700
101778	32.100
101779	38.300
109726	44.600
109785	50.800

- Heavy Duty Spindles**
Heavy Duty Spindle SLS 40/80
Heavy Duty Spindle SLS 80/140
Heavy Duty Spindle SLS 100/180
Heavy Duty Spindle SLS 140/240
Heavy Duty Spindle SLS 200/300
Heavy Duty Spindle SLS 260/360
Heavy Duty Spindle SLS 320/420
Heavy Duty Spindle SLS 380/480

Used as adjustable spindle for truss beams made of Steel Walers SRU and Climbing Rails RCS.

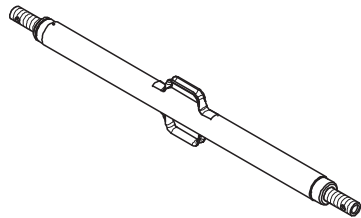

A	min. L	max. L
344	400	800
746	800	1400
946	1000	1800
1346	1400	2400
1944	2000	3000
2544	2600	3600
3144	3200	4200
3744	3800	4800

Note

Permissible load see PERI Design Tables.

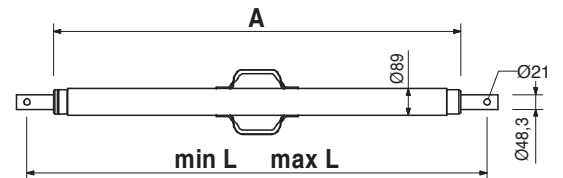

Accessories

104031	0.462
018060	0.030
110477	3.990

- Fitting Pin Ø 21 x 120**
Cotter Pin 4/1, galv.
Spindle Adapter SLS/RCS

129695	0.023
--------	-------

- Reducing Sleeve Ø 26 - 21, galv.**
 For reducing the hole diameter from Ø 26 to Ø 21 mm in fitting pin connections.

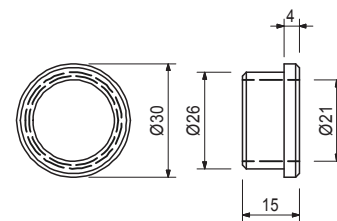
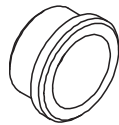

129772	25.600
--------	--------

- Platform Beam SCS 120**
 For use as finishing and concreting platform for double-sided application of SCS Climbing Bracket.

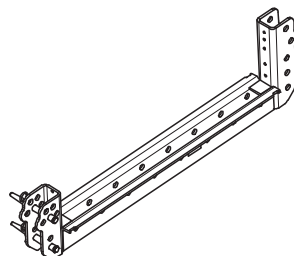

Complete with

- 2 pc. 104031 Fitting Pin Ø 21 x 120
 2 pc. 018060 Cotter Pin 4/1, galv.

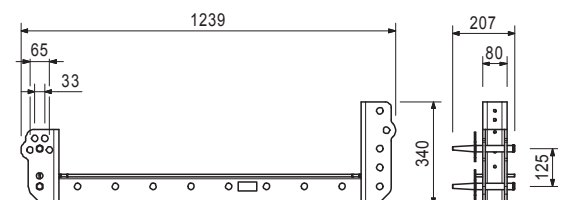

Item no.	Weight kg
129708	50.100

Platform Post Double SCS 232

For mounting finishing platforms for double-sided application of SCS Climbing Bracket.

Complete with

- 2 pc. 104031 Fitting Pin \varnothing 21 x 120
- 2 pc. 018060 Cotter Pin 4/1, galv.
- 2 pc. 129704 Spacer M20-102
- 2 pc. 118578 Platform Post SCS 232

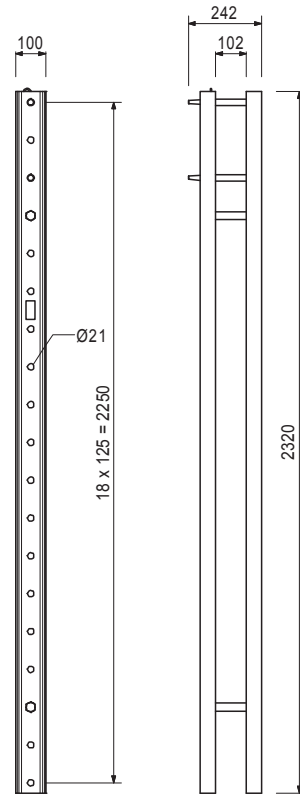

Accessories

129707	9.360
129772	25.600
129699	1.810

Platform Post Connector SCS

Platform Beam SCS 120

Scaffold Tube Connector SCS 48

129707	9.360
--------	-------

Platform Post Connector SCS

For mounting and additional Platform Post Double SCS 232 for formwork heights > 3.90 m up to 6.00 m.

Complete with

- 2 pc. 104031 Fitting Pin \varnothing 21 x 120
- 2 pc. 018060 Cotter Pin 4/1, galv.
- 1 pc. 017040 Screw-On Coupler AK 48, galv.

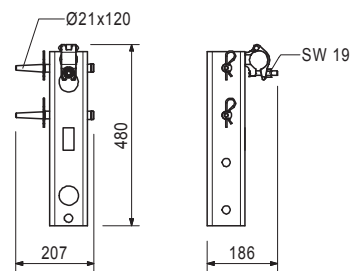

129704	0.645
--------	-------

Spacer M20-102

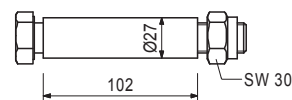
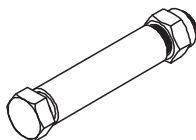

Item no.	Weight kg
129699	1.810

Scaffold Tube Connector SCS 48

For stiffening Platform Post Double SCS 232 with Scaffold Tubes Ø 48.

Complete with

1 pc. 104031 Fitting Pin Ø 21 x 120
1 pc. 017040 Screw-On Coupler AK 48, galv.

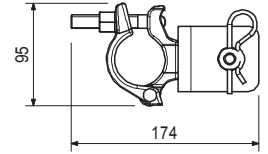
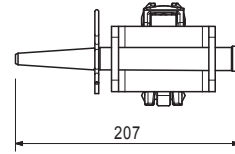
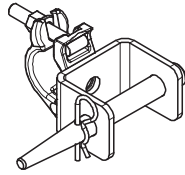

129778	1.440
--------	-------

Platform Post Stop SCS

Temporary stopper of finishing platform during moving in the first standard cycle.

Complete with

1 pc. 109612 Bolt ISO 4014 M24 x 130-8.8, galv.
1 pc. 105032 Nut ISO 7042 M24-8, galv.

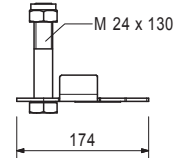
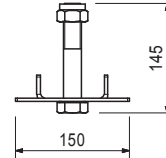
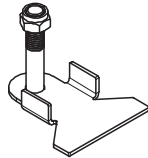

127099	12.000
--------	--------

Adapter Adjusting Unit SCS/RCS

Adapter for using a Climbing Rail RCS as Strongback with SCS Climbing System.

Complete with

2 pc. 111567 Fitting Pin Ø 26 x 120
2 pc. 104031 Fitting Pin Ø 21 x 120
4 pc. 018060 Cotter Pin 4/1, galv.

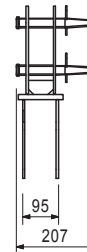
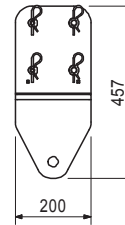
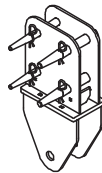

		Scaffold Tubes Steel	
026415	3.550	Scaff. Tube Steel Ø 48.3 x 3.2, special length	
026417	0.000	Cutting Cost Scaffold Tube	
026411	3.550	Scaff. Tube Steel Ø 48.3 x 3.2, l = 1.0 m	1000
026412	7.100	Scaff. Tube Steel Ø 48.3 x 3.2, l = 2.0 m	2000
125976	8.900	Scaff. Tube Steel Ø 48.3 x 3.2, l = 2.5 m	2500
026413	10.650	Scaff. Tube Steel Ø 48.3 x 3.2, l = 3.0 m	3000
114287	12.500	Scaff. Tube Steel Ø 48.3 x 3.2, l = 3.5 m	3500
026414	14.200	Scaff. Tube Steel Ø 48.3 x 3.2, l = 4.0 m	4000
026419	17.750	Scaff. Tube Steel Ø 48.3 x 3.2, l = 5.0 m	5000
026418	21.600	Scaff. Tube Steel Ø 48.3 x 3.2, l = 6.0 m	6000

L

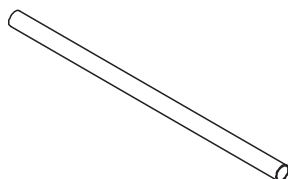

Item no.	Weight kg
017010	1.400

Swivel Coupling DK 48/48, galv.
For Scaffold Tubes \varnothing 48 mm.

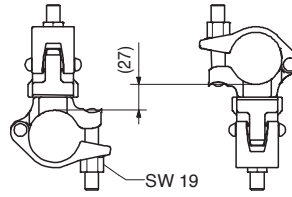
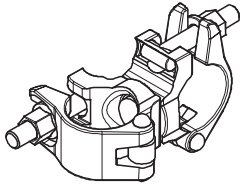

017020	1.120
--------	-------

Standard Coupler NK 48/48, galv.
For Scaffold Tubes \varnothing 48 mm.

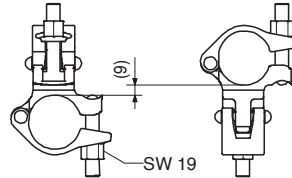
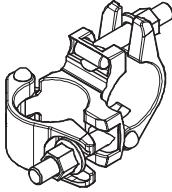

110084	2.310
--------	-------

Scaffold Tube Adapter \varnothing 48 RCS
For connecting Scaffold Tubes \varnothing 48 mm to Climbing Rails RCS.

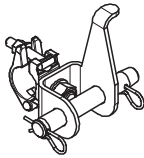

Complete with

- 1 pc. 017040 Screw-On Coupler AK 48, galv.
- 1 pc. 710894 Pin \varnothing 25 x 180, geomet.
- 2 pc. 018060 Cotter Pin 4/1, galv.

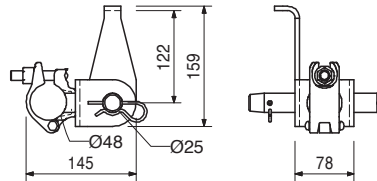

123664	2.520
--------	-------

Connection Plate SCS \varnothing 21-125
For connecting the Guardrail Post to the Platform Post when using as inclined Platform Beam.

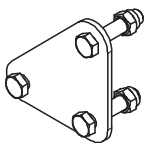

Complete with

- 2 pc. 710226 Bolt ISO 4014 M20 x 90-8.8, galv.
- 1 pc. 706458 Bolt ISO 4017 M20 x 40-8.8, galv.
- 3 pc. 781053 Nut ISO 7042 M20-8, galv.

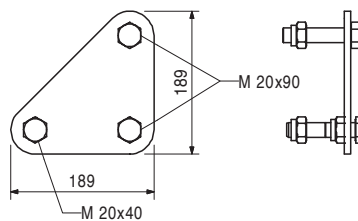

Item no.	Weight kg
113762	0.884

Guardrail Conn. Plate ACS/SCS

For assembling scaffold tubes \varnothing 48 or \varnothing 60 as guardrail by means of Bail Pin A64 on Guardrail Posts ACS, SCS and GT 24. Fixation by Hex. Bolt M8, M12, M16 or Wood Screw \varnothing 8.

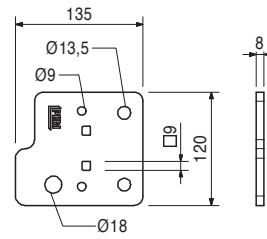
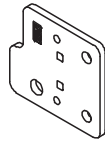

110296	0.220
710330	0.017

Accessories

Clamp A64 DIN 3570 M12, galv.

Nut ISO 4032 M12-8, galv.

110296	0.220
--------	-------

Clamp A64 DIN 3570 M12, galv.

For assembling Scaffold Tubes \varnothing 48 or \varnothing 60.

Note

Wrench size SW 19.

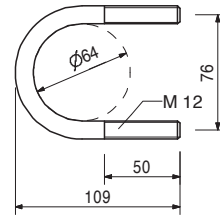
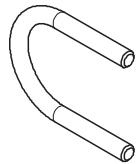

710330	0.017
--------	-------

Accessories

Nut ISO 4032 M12-8, galv.

710330	0.017
--------	-------

Nut ISO 4032 M12-8, galv.

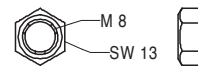

Item no.	Weight kg
126088	4.390

Guardrail Post Holder Multi

For fixing of an end guardrail post on Girders GT 24, VT 20 or Timbers 80/160.
Fixing of the guardrail posts by means of Hex. Bolts M20 or Clamp A64.

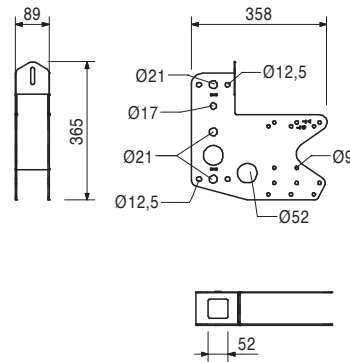
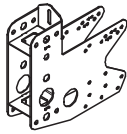

710285	0.050
024090	0.005
024470	0.008

Accessories

Bolt ISO 4014 M8 x 100-8.8, galv.

Nut ISO 4032 M8-8, galv.

TSS-Torx 6 x 60, galv.

116477	10.600
--------	--------

Platform Beam Support RCS

Support for additional Platform Beams 2 x GT 24 or VT 20 when used with Cross Beam RCS 220. With connector for Guardrail Post RCS.

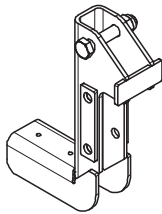

Complete with

1 pc. 109612 Bolt ISO 4014 M24 x 130-8.8, galv.

1 pc. 105032 Nut ISO 7042 M24-8, galv.

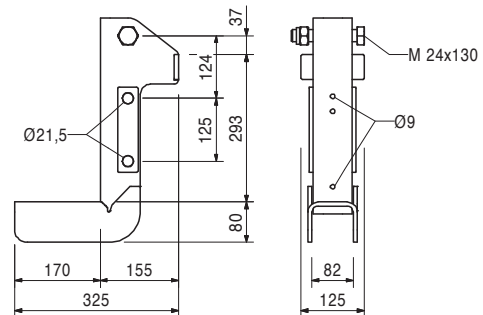

110330	0.865
--------	-------

Girder Fixation M20

For the fixation of 80 mm wide decking supports made of wood on Platform Beams with suitable boring of Ø 21 mm.

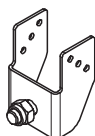

Complete with

1 pc. 706458 Bolt ISO 4017 M20 x 40-8.8, galv.

1 pc. 781053 Nut ISO 7042 M20-8, galv.

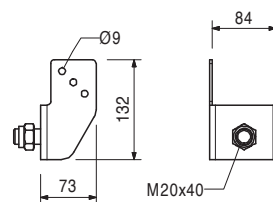

024470	0.008
--------	-------

Accessories

TSS-Torx 6 x 60, galv.

Item no.	Weight kg
129722	0.746

Cross Connector GT 24 / VT 20

For the connection of crossing GT 24 and VT 20 Formwork Girders.

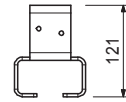
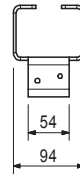

024540	0.005
024470	0.008

Accessories

TSS-Torx 6 x 40, galv.

TSS-Torx 6 x 60, galv.

129724	0.817
--------	-------

Cross Connector GT 24 / GT 24

For the connection of crossing GT 24 Formwork Girders.

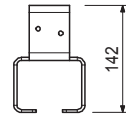
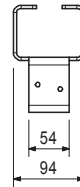

024540	0.005
024470	0.008

Accessories

TSS-Torx 6 x 40, galv.

TSS-Torx 6 x 60, galv.

129817	0.674
--------	-------

Cross Connector VT 20 / VT 20

For the connection of crossing VT 20 Formwork Girders.

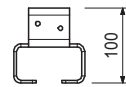
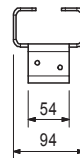
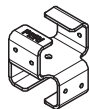

024540	0.005
024470	0.008

Accessories

TSS-Torx 6 x 40, galv.

TSS-Torx 6 x 60, galv.

Item no.	Weight kg
109720	26.600

Guardrail Post RCS 226

For assembly of the guardrail on the main platform with RCS formwork scaffolding or as horizontal strut in the bracing.

Complete with

2 pc. 104477 Bolt ISO 4014 M20 x 120-8.8, galv.
2 pc. 781053 Nut ISO 7042 M20-8, galv.

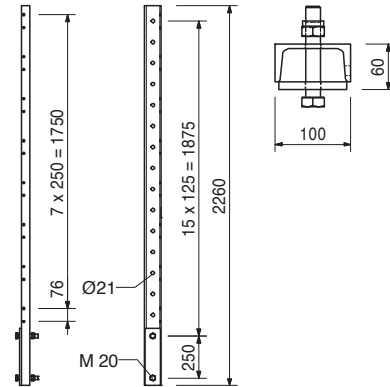

711084	0.420
--------	-------

Bolt ISO 4014 M20 x 150-8.8, galv.

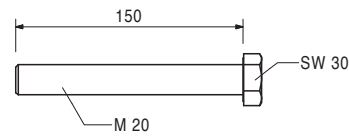
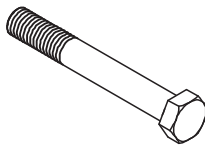

Accessories

781053	0.065
--------	-------

Nut ISO 7042 M20-8, galv.

118582	1.850
--------	-------

Mounting Ring SCS M30

For anchoring of the SCS Bracket at high vertical loads.

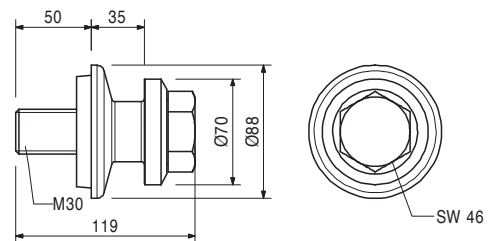
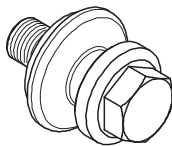

Accessories

030920	1.650
--------	-------

Climbing Cone-2 M30/DW 20, galv.

SCS Climbing System



Item no.	Weight kg
030920	1.650

Climbing Cone-2 M30/DW 20, galv.
Anchor System M30.
For anchoring climbing systems.

Note
Separate design information on request.

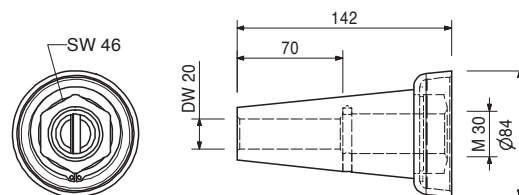
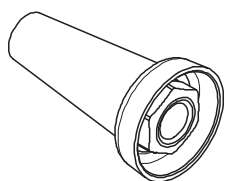

Accessories

030860	0.792
030700	2.560
030745	2.600

Threaded Anchor Plate DW 20
Tie Rod DW 20, spec. length
Tie Rod B 20, spec. length

030700	2.560
030800	0.000

Tie Rod DW 20
Tie Rod DW 20, spec. length
Cutting Cost Tie Rod DW 20/B 20

Note
Non-weldable! Take official approval into consideration!

Technical Data
Permissible tension force 150 kN.

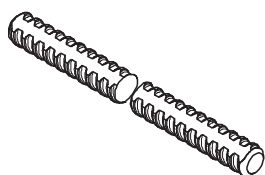

030745	2.600
030800	0.000

Tie Rod B 20
Tie Rod B 20, spec. length
Cutting Cost Tie Rod DW 20/B 20

Note
Weldable! Take official approval into consideration!

Technical Data
Permissible tension force 150 kN.

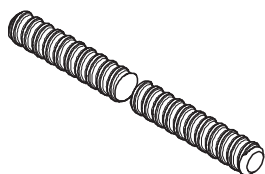

030860	0.792
--------	-------

Threaded Anchor Plate DW 20
For use with Tie Rod DW 20, B 20 or Screw-On Cone-2 M24/DW 20. For anchoring in concrete.

Note
Lost anchor part.

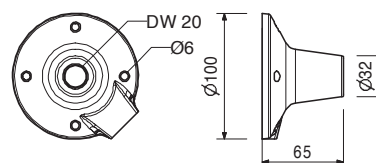
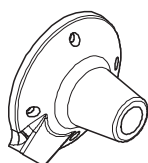

Item no.	Weight kg
031653	0.364

KK Concrete Cone M30-80/52
 For closing anchor points with Climbing Cone-2 M30/DW 20 or Screw-On Cone M30/DW 26.

Note
 Delivery unit 50 pieces.

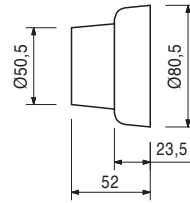
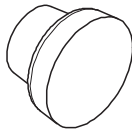

Accessories

113127	5.400
--------	-------

Glue for Concrete Cones-3, 5,4-kg-Set

029450	0.339
--------	-------

Advancing Screw M30, galv.
 For fixing the M30 anchor system if the plywood formlining is drilled through.

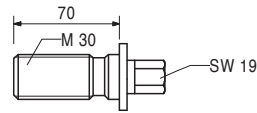
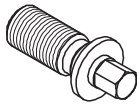

Accessories

029380	0.200
--------	-------

Anchor Positioning Plate M30, galv.

029380	0.200
--------	-------

Anchor Positioning Plate M30, galv.
 For fixing the M30 anchor system if the plywood formlining is drilled through.

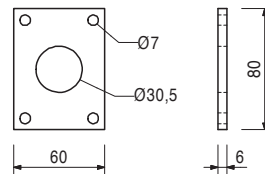
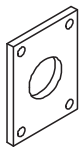

Accessories

029440	0.005
--------	-------

Lag Screw DIN 571 6 x 20, galv.

026450	0.214
--------	-------

Anchor Positioning Stud M30, galv.
 For fixing the M30 anchor system if the plywood formlining is not drilled through.

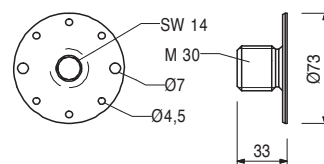

Accessories

027212	0.445
710312	0.005

Allen Key SW 14, long
Nail 3 x 80

Item no.	Weight kg
118769	1.880

Mounting Bolt SCS M36

For anchoring of the SCS Bracket at high tension forces.

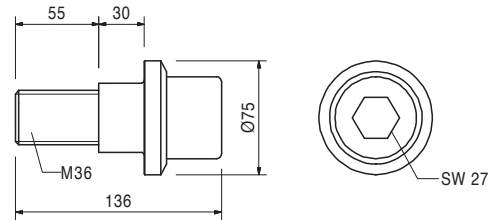
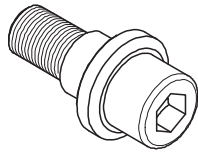

Accessories

030940	3.040
--------	-------

Climbing Cone-2 M36/DW 26, galv.

118772	2.550
--------	-------

Mounting Ring SCS M36

For anchoring of the SCS Bracket at high tension forces and vertical loads.

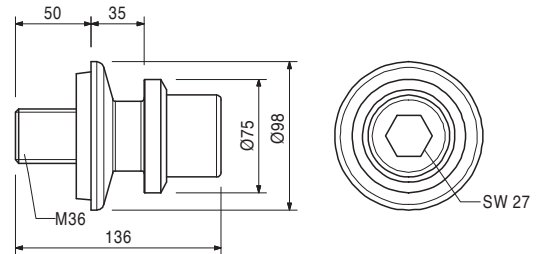
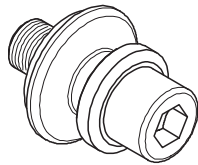

Accessories

030940	3.040
--------	-------

Climbing Cone-2 M36/DW 26, galv.

030940	3.040
--------	-------

Climbing Cone-2 M36/DW 26, galv.

Tie System M36.
For anchoring of climbing systems.

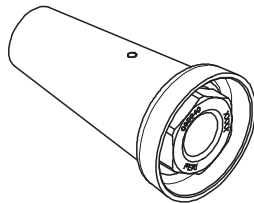

Note

Separate design information on request.

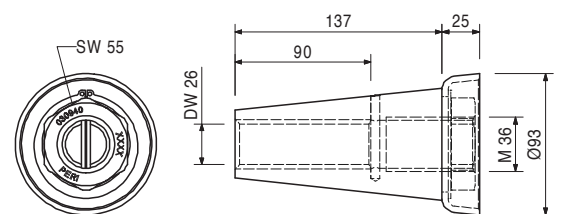

Accessories

030870	1.260
030340	4.480

Threaded Anchor Plate DW 26

Tie Rod DW 26, spec. length

030340	4.480
030500	0.000

Tie Rod DW 26

Tie Rod DW 26, spec. length

Cutting Cost Tie Rod DW 26

Note

Non-weldable! Take official approval into consideration!

Technical Data

Permissible tension force 250 kN.

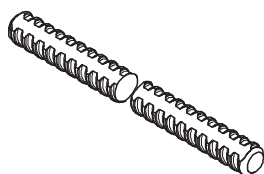

Item no.	Weight kg
030870	1.260

Threaded Anchor Plate DW 26

For use with Tie Rod DW 26 or Screw-On Cone M36/DW 26. For anchoring in concrete.

Note
Lost anchor part.

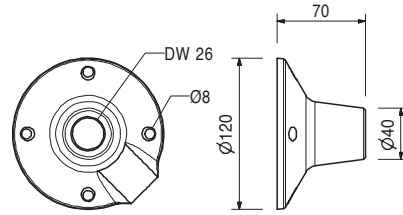
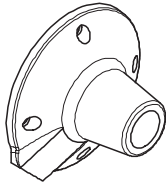

031654	0.512
--------	-------

KK Concrete Cone M36-90/52

For closing anchor points with Climbing Cone-2 M36/DW 26.

Note
Delivery unit 50 pieces.

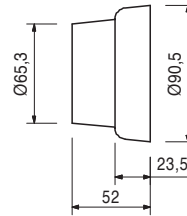
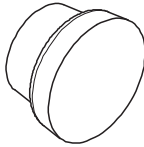

Accessories

113127	5.400
--------	-------

Glue for Concrete Cones-3, 5,4-kg-Set

113127	5.400
--------	-------

Glue for Concrete Cones-3, 5,4-kg-Set

For bonding PERI concrete cones.

Note
See Safety Data sheet!
Consisting of:
6 x Component A, 6 x Component B
2 x Stirring Container, 3 x Stirring Staff

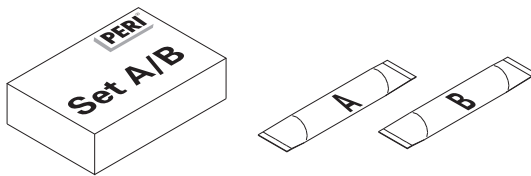

029390	0.170
--------	-------

Anchor Positioning Plate M36, galv.

For fixing the M36 anchor system if the plywood formlining is drilled through.

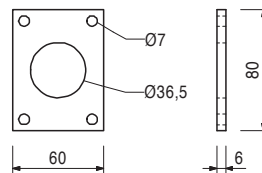
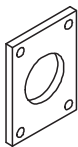

Accessories

029440	0.005
--------	-------

Lag Screw DIN 571 6 x 20, galv.

Item no.	Weight kg
029430	0.930

Bolt ISO 4017 M36 x 70-8.8, galv.
Bolt for anchoring of climbing systems and as advancing bolt.

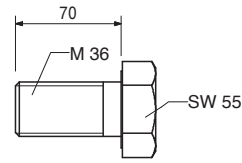
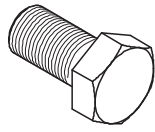

026460	0.308
--------	-------

Anchor Positioning Stud M36, galv.
For fixing the M36 anchor system if the plywood formlining is not drilled through.

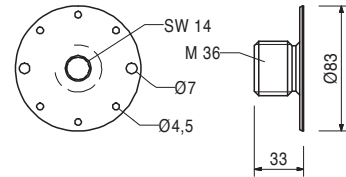

Accessories

027212	0.445
710312	0.005

Allen Key SW 14, long
Nail 3 x 80

123819	9.380
--------	-------

Bracing Shoe SCS M30/DW20
Used as compression point at starter sections with optional connections to Scaffold Tube Bracing Ø 48, Vertical Tie Rod DW 20 Suspension, Climbing Anchor M36, Diagonal Strut SCS or Heavy Duty Spindle SCS.

Complete with
1 pc. 017040 Screw-On Coupler AK 48, galv.

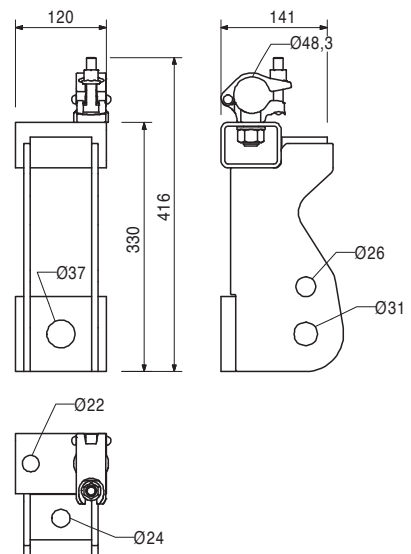
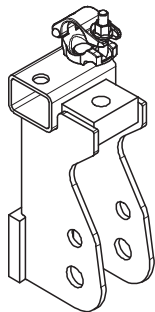

Accessories

029420	0.590
029430	0.930

Bolt ISO 4017 M30 x 70-8.8, galv.
Bolt ISO 4017 M36 x 70-8.8, galv.

Item no.	Weight kg
030580	0.371

Hex. Nut DW 20 SW 36/60, weldable
For anchoring with Tie Rod DW 20 and B 20.

Note
Weldable!
Technical Data
Permissible load 150 kN.

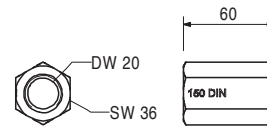
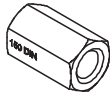

114082	2.860
--------	-------

Counterplate RCS DW 20
Counterplate with centring for anchoring through the Climbing Rail RCS.

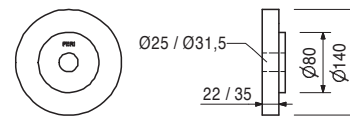

030990	0.786
--------	-------

Wingnut DW 20, galv.
For anchoring with Tie Rod DW 20 and B 20.

Technical Data
Permissible load 150 kN.

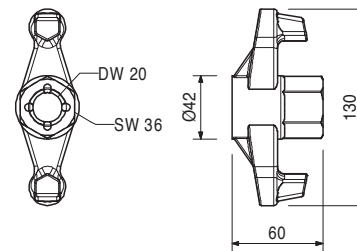

051250	2.790
--------	-------

Tension Belt, l = 5.70 m, 2.5 t
To prevent climbing systems from tipping over due to wind loads.

Note
Follow Instructions for Assembly and Use!
Technical Data
Permissible tension force 2.5 t.

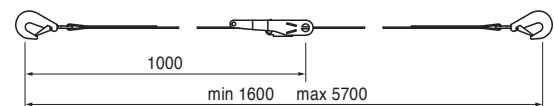
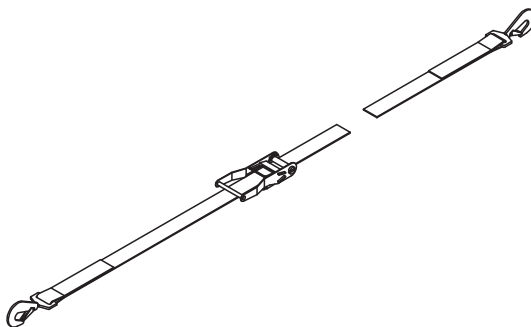

Item no.	Weight kg
110469	1.660

Tension Belt Connector Wall M36

To connect Tension Belt to the previous anchor M30 or M36.

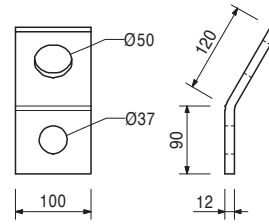
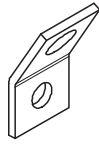

Accessories

029420	0.590	Bolt ISO 4017 M30 x 70-8.8, galv.
029430	0.930	Bolt ISO 4017 M36 x 70-8.8, galv.

104477	0.300	Bolt ISO 4014 M20 x 120-8.8, galv.
--------	-------	---

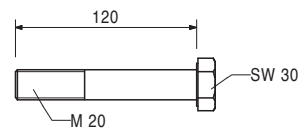
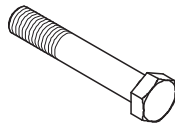

Accessories

781053	0.065	Nut ISO 7042 M20-8, galv.
--------	-------	----------------------------------

781053	0.065	Nut ISO 7042 M20-8, galv. Self-locking.
--------	-------	---

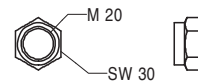

129693	3.130	Tension Anchor Connector CB/SCS
--------	-------	--

For connecting the wind suspension with Tie Rod DW 15 to the Crossbeam Unit SCS 250 / 190 or CB Climbing Bracket.

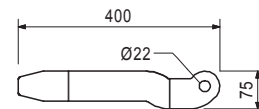
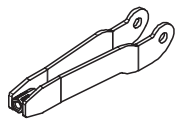

Accessories

711084	0.420	Bolt ISO 4014 M20 x 150-8.8, galv.
781053	0.065	Nut ISO 7042 M20-8, galv.

Item no.	Weight kg
030030	1.440
030050	0.000

Tie Rod DW 15
Tie Rod DW 15, spec. length
Cutting Cost Tie Rod DW 15, B 15

Note
 Non-weldable! Take official approval into consideration!
Technical Data
 Permissible tension force 90 kN.

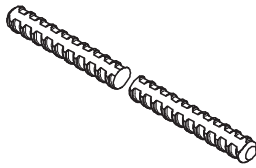

107008	4.100
--------	-------

Wall Tension Anchor
 Alternative wall connector to prevent tipping over due to wind loads with Tie Rod DW 15. Including Turnbuckle CB M20/DW 15.

Complete with
 1 pc. 027170 Pin Ø 16 x 42, galv.
 1 pc. 018060 Cotter Pin 4/1, galv.

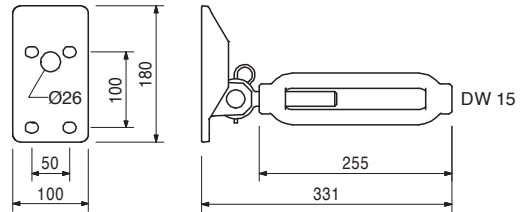
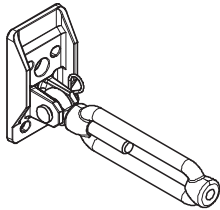

Accessories
Bolt ISO 4014 M24 x 70-10.9, glav.

026430	0.334
--------	-------

Bolt ISO 4014 M24 x 70-10.9, glav.
 High-strength bolt for anchoring climbing systems.

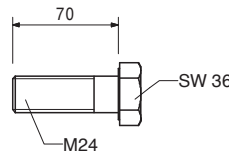
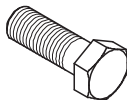

116532	1.890
--------	-------

Tie Yoke VARIOKIT Ø 22 / DW 15
 For assembling in Steel Waler SRU.

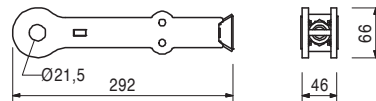
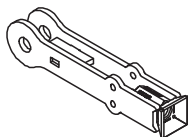

Item no.	Weight kg
115375	6.100

Articulated Spanner RCS DW 15

For tensioning and as an articulated connection to the Climbing Rail RCS, Steel Waler SRU or Bracing Shoe RCS for bracing with DW 15.

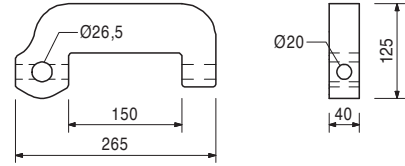
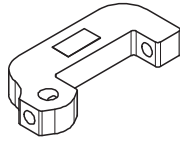

Accessories

104031	0.462	Fitting Pin Ø 21 x 120
018060	0.030	Cotter Pin 4/1, galv.
111567	0.729	Fitting Pin Ø 26 x 120
022230	0.033	Cotter Pin 5/1, galv.
030070	0.222	Hex. Nut DW 15 SW 30/50, galv.

030090	0.402	Hex. Nut DW 15 SW 30/108, galv. For coupling Tie Rod DW 15 and B 15.
--------	-------	--

Technical Data

Permissible load 90 kN.

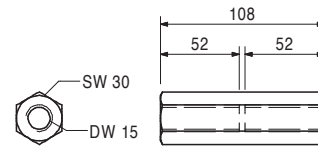
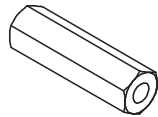

030070	0.222	Hex. Nut DW 15 SW 30/50, galv. For anchoring with Tie Rod DW 15 and B 15.
--------	-------	---

Technical Data

Permissible load 90 kN.

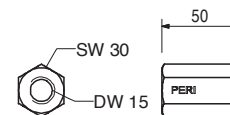

129831	2.740	Bracing Shoe SCS M30/M24 To connect wind suspension to the previous anchor.
--------	-------	---

Complete with

1 pc. 104031 Fitting Pin Ø 21 x 120
1 pc. 018060 Cotter Pin 4/1, galv.

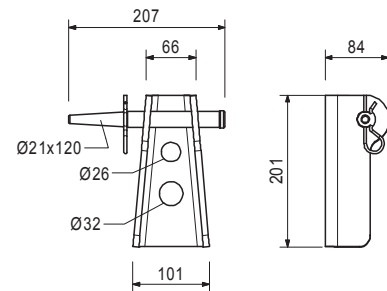
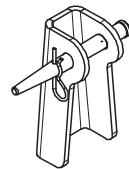

Accessories

123843	0.623	Bolt ISO 4017 M30 x 80-10.9
026430	0.334	Bolt ISO 4014 M24 x 70-10.9, glav.

Item no.	Weight kg	
123843	0.623	Bolt ISO 4017 M30 x 80-10.9

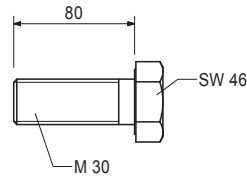
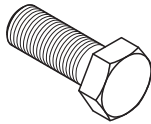

124630	5.330	Tie Yoke SCS Ø 60 - 200 For anchoring of Starter Bar SCS with Tie Rods DW 15.
--------	-------	---

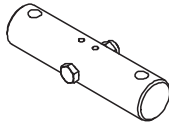

Complete with
 1 pc. 110755 Tie Yoke SRU
 1 pc. 710222 Bolt ISO 4014 M16 x 80-8.8, galv.
 1 pc. 070890 Nut ISO 7042 M16-8, galv.

Technical Data
 Permissible load 2 x 90 kN.
 Valid for Tie Yokes SRU with centre hole Ø 18 rectangular to outside holes Ø 18.

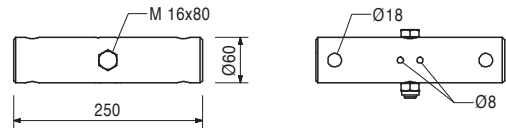

030100	0.439	Wingnut DW 15, galv. For anchoring with Tie Rod DW 15 and B 15.
--------	-------	---

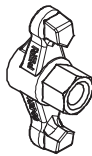

Technical Data
 Permissible load 90 kN.

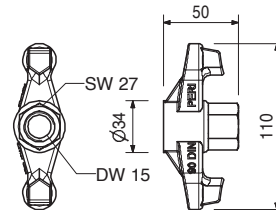

030090	0.402	Hex. Nut DW 15 SW 30/108, galv. For coupling Tie Rod DW 15 and B 15.
--------	-------	--

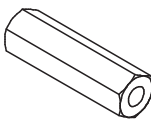

Technical Data
 Permissible load 90 kN.

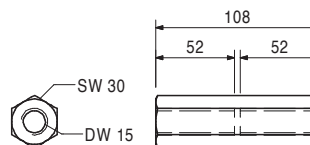

Item no.	Weight kg
103874	30.900
103877	38.100
103886	44.700
103889	52.000
103898	58.600
103892	65.600
103929	72.000
103903	81.000

Steel Walers Universal SRU U120
Steel Waler Universal SRU U120, l = 1.22 m
Steel Waler Universal SRU U120, l = 1.47 m
Steel Waler Universal SRU U120, l = 1.72 m
Steel Waler Universal SRU U120, l = 1.97 m
Steel Waler Universal SRU U120, l = 2.22 m
Steel Waler Universal SRU U120, l = 2.47 m
Steel Waler Universal SRU U120, l = 2.72 m
Steel Waler Universal SRU U120, l = 2.97 m
 Universal steel waler profiles with profile U120 used as waling for girder wall formwork and for diverse special applications. With adjustable spacers.

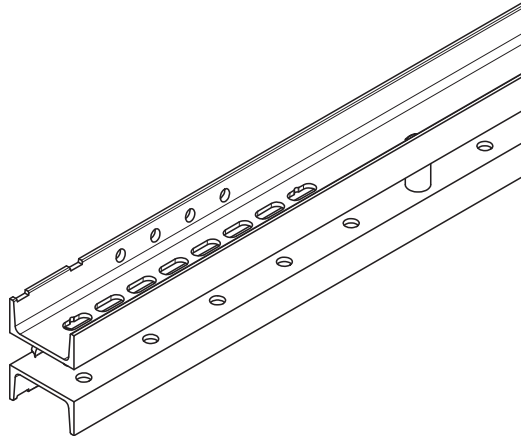

L
1222
1472
1722
1972
2222
2472
2722
2972

Note
 Permissible load: see PERI Design Tables.

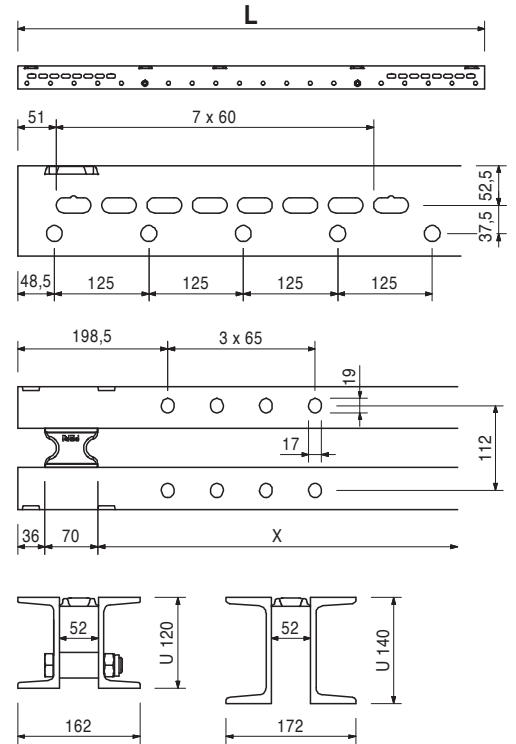

030370	1.660
--------	-------

Wingnut Pivot Plate DW 15, galv.
 For anchoring with Tie Rod DW 15 and B 15. With pivoting captive nut. Maximum angle of tilting 8°.

Note
 Wrench size SW 27.
Technical Data
 Permissible load 90 kN.

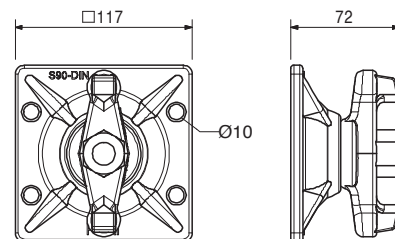
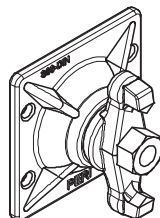

Item no.	Weight kg
030005	0.720
030030	1.440
030050	0.000

Tie Rod DW 15
Tie Rod DW 15, l = 0.50 m
Tie Rod DW 15, spec. length
Cutting Cost Tie Rod DW 15, B 15

Note
 Non-weldable! Take official approval into consideration!
Technical Data
 Permissible tension force 90 kN.

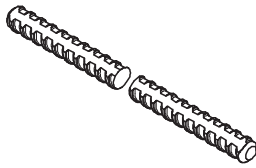

030840	0.515
--------	-------

Threaded Anchor Plate DW 15
 For use with Tie Rod DW 15 or B 15. For anchoring in concrete.

Note
 Lost anchor part.

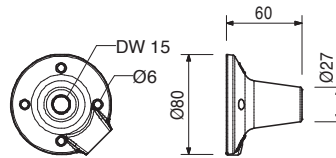
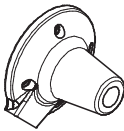

031580	0.440
--------	-------

V-Tie Holder DW 15
 For easy installation of DW 15 Tie Rods at 45° inclinations.

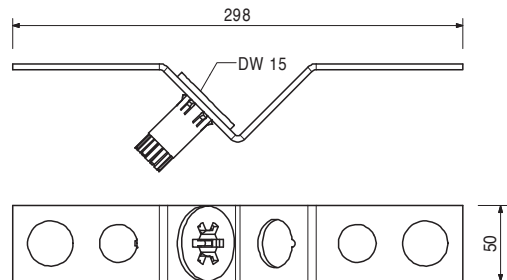
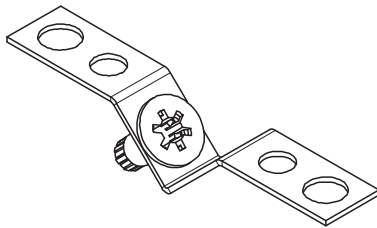

031631	0.345
--------	-------

Leading Anchor Coupler DW 15, compl.
 For easy installation of DW 15 Tie Rods at 45° inclinations.

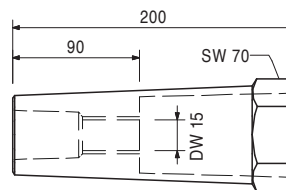
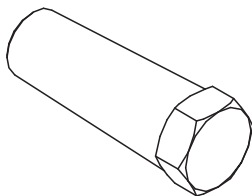

SCS Climbing System

Item no.	Weight kg
072180	0.560

Ratchet Wrench 1/2"

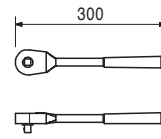
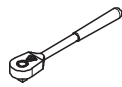

029610	5.300
--------	-------

Ratchet Wrench 1"

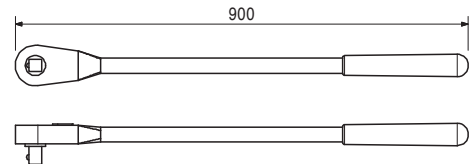
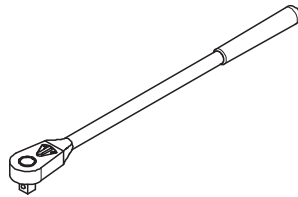

123751	0.216
--------	-------

Socket SW 19-1/2" L

Fits to Hex. Bolts M12. To operate the Carriage SCS with Drive Shaft SW 19.

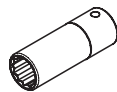

104823	0.175
--------	-------

Socket SW 30-1/2"

Fits to Hex. Bolts M20. To operate the Adjusting Unit SCS.

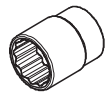

029630	0.580
--------	-------

Socket SW 46-1"

Fits to Hex. Bolts M30.

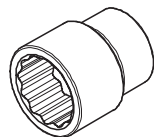

029640	1.000
--------	-------

Socket SW 55-1"

Fits to Hex. Bolts M36.

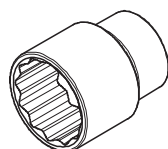

Item no. Weight kg

123750 0.776

Hexagon Socket SW 27-1"

Fits to Cyl. Bolts ISO 4762 M36.

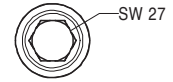
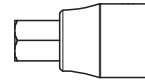
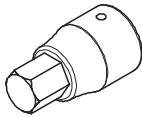

027212

0.445

Allen Key SW 14, long

Fits to PERI Anchor Positioning Studs and Allen Key Bolts M16.

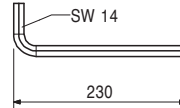
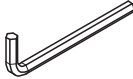

PERI International

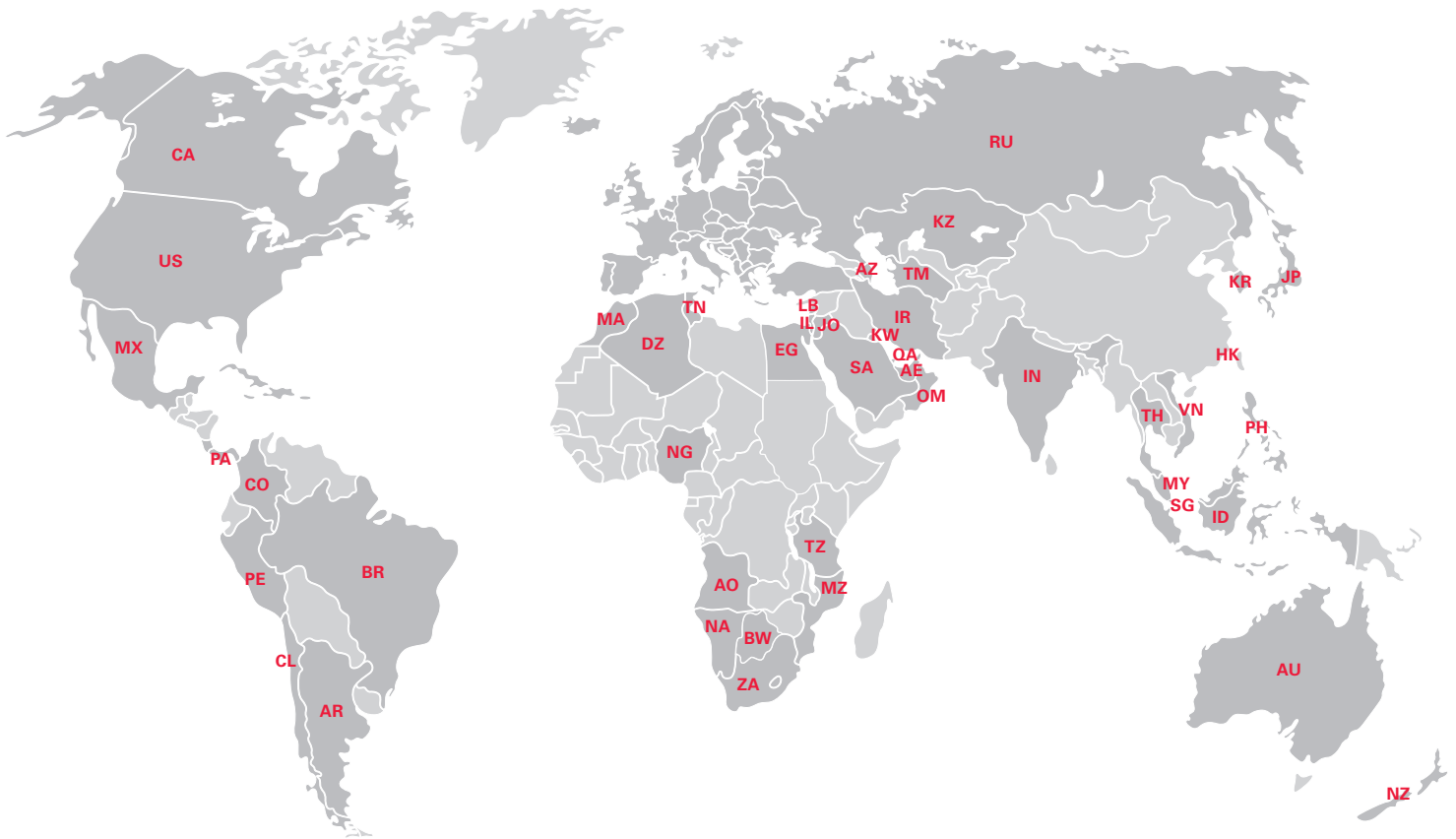

North America

- CA** Canada
PERI Formwork Systems, Inc.
www.peri.ca
- MX** Mexico
PERI Cimbras y Andamios, S.A. de C.V.
www.peri.com.mx
- PA** Panama
PERI Panama Inc.
www.peri.com.pa
- US** USA
PERI Formwork Systems, Inc.
www.peri-usa.com

South America

- AR** Argentina
PERI S.A.
www.peri.com.ar
- BR** Brazil
PERI Formas e Escoramentos Ltda.
www.peribrasil.com.br
- CL** Chile
PERI Chile Ltda.
www.peri.cl
- CO** Colombia
PERI S.A.S.
www.peri.com.co
- PE** Peru
PERI Peruana S.A.C.
www.peri.com.pe

Africa

- AO** Angola
Pericofragens, Lda.
www.peri.pt
- DZ** Algeria
S.A.R.L. PERI
www.peri.dz
- BW** Botswana
PERI (Proprietary) Limited
www.peri.co.bw
- EG** Egypt
Egypt Branch Office
www.peri.com.eg
- MA** Morocco
PERI S.A.
www.peri.ma
- MZ** Mozambique
PERI (Pty.) Ltd.
www.peri.co.mz
- NA** Namibia
PERI (Pty.) Ltd.
www.peri.na
- NG** Nigeria
PERI Nigeria Ltd.
www.peri.ng
- TN** Tunisia
PERI S.A.U.
www.peri.es
- TZ** Tanzania
PERI Formwork and Scaffolding Ltd
www.peritanzania.com
- ZA** South Africa
PERI Formwork Scaffolding (Pty) Ltd
www.peri.co.za

Asia

- AE** United Arab Emirates
PERI (L.L.C.)
www.perime.com
- AZ** Azerbaijan
PERI Representative Office
www.peri.com.tr
- HK** Hong Kong
PERI (Hong Kong) Limited
www.perihk.com
- ID** Indonesia
PT Beton Perkasa Wijaksana
www.betonperkasa.com
- IL** Israel
PERI F.E. Ltd.
www.peri.co.il
- IN** India
PERI (India) Pvt Ltd
www.peri.in
- IR** Iran
PERI Pars. Ltd.
www.peri.ir
- JO** Jordan
PERI GmbH – Jordan
www.peri.com
- JP** Japan
PERI Japan K.K.
www.perijapan.jp
- KR** Korea
PERI (Korea) Ltd.
www.perikorea.com
- KW** Kuwait
PERI Kuwait W.L.L.
www.peri.com.kw
- KZ** Kazakhstan
TOO PERI Kazakhstan
www.peri.kz
- LB** Lebanon
PERI Lebanon Sarl
lebanon@peri.de
- MY** Malaysia
PERI Formwork Malaysia Sdn. Bhd.
www.perimalaysia.com
- OM** Oman
PERI (L.L.C.)
www.perime.com
- PH** Philippines
PERI-Asia Philippines, INC.
www.peri.com.ph
- QA** Qatar
PERI Qatar LLC
www.peri.qa
- SA** Saudi Arabia
PERI Saudi Arabia Ltd.
www.peri.com.sa
- SG** Singapore
PERI Asia Pte Ltd
www.periasia.com
- TM** Turkmenistan
PERI Kalıp ve İşkeleleri
www.peri.com.tr
- TH** Thailand
Peri (Thailand) Co., Ltd.
www.peri.co.th
- VN** Vietnam
PERI ASIA PTE LTD
www.peri.com.vn



PERI GmbH
Formwork Scaffolding Engineering
Rudolf-Diesel-Strasse 19
89264 Weissenhorn
Germany
Tel. +49 (0)7309.950-0
Fax +49 (0)7309.951-0
info@peri.com
www.peri.com



Oceania

AU Australia
PERI Australia Pty. Ltd.
www.periaus.com.au

NZ New Zealand
PERI Australia Pty. Limited
www.peri.co.nz

Europe

AL Albania
PERI Kalıp ve İskeleleri
www.peri.com.tr

AT Austria
PERI Ges.mbH
www.peri.at

BA Bosnia and Herzegovina
PERI oplate i skele d.o.o
www.peri.com.hr

BE Belgium
N.V. PERI S.A.
www.peri.be

BG Bulgaria
PERI Bulgaria EOOD
www.peri.bg

BY Belorussia
IOOO PERI
www.peri.by

CH Switzerland
PERI AG
www.peri.ch

CZ Czech Republic
PERI spol. s r.o.
www.peri.cz

DE Germany
PERI GmbH
www.peri.de

DK Denmark
PERI Danmark A/S
www.peri.dk

EE Estonia
PERI AS
www.peri.ee

ES Spain
PERI S.A.U.
www.peri.es

FI Finland
PERI Suomi Ltd. Oy
www.perisuomi.fi

FR France
PERI S.A.S.
www.peri.fr

GB United Kingdom
PERI Ltd.
www.peri.ltd.uk

GR Greece
PERI Hellas Ltd.
www.perihellas.gr

HR Croatia
PERI oplate i skele d.o.o.
www.peri.com.hr

HU Hungary
PERI Kft.
www.peri.hu

IR Ireland
Siteserv Access & Formwork
www.siteservaccess.ie

IS Iceland
Armar ehf.
www.armor.is

IT Italy
PERI S.r.l.
www.peri.it

LT Lithuania
PERI UAB
www.peri.lt

LU Luxembourg
N.V. PERI S.A.
www.peri.lu

LV Latvia
PERI SIA
www.peri-latvija.lv

NL Netherlands
PERI B.V.
www.peri.nl

NO Norway
PERI Norge AS
www.peri.no

PL Poland
PERI Polska Sp. z o.o.
www.peri.com.pl

PT Portugal
Pericofragens Lda.
www.peri.pt

RO Romania
PERI România SRL
www.peri.ro

RS Serbia
PERI oplate d.o.o.
www.peri.rs

RU Russia
OOO PERI
www.peri.ru

SE Sweden
PERI Sverige AB
www.peri.se

SI Slovenia
PERI oplate i skele d.o.o
www.peri.com.hr

SK Slovakia
PERI spol. s. r.o.
www.peri.sk

TR Turkey
PERI Kalıp ve İskeleleri
www.peri.com.tr

UA Ukraine
TOW PERI
www.peri.ua

**The optimal System
for every Project and
every Requirement**



Wall Formwork



Column Formwork



Slab Formwork



Climbing Systems



Bridge Formwork



Tunnel Formwork



Shoring Systems

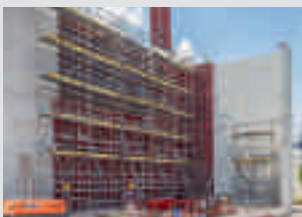

Construction Scaffold



Facade Scaffold



Industrial Scaffold



Access



Protection Scaffold



Safety Systems



System-Independent Accessories



Services



PERI GmbH
Formwork Scaffolding Engineering
 Rudolf-Diesel-Strasse 19
 89264 Weissenhorn
 Germany
 Tel. +49 (0)7309.950-0
 Fax +49 (0)7309.951-0
 info@peri.com
 www.peri.com